

SOKKIA

Series30RK

SET230RK/RK3

SET330RK/RK3

SET530RK/RK3

SET630RK

Reflectorless Total Station



SET230RK3/330RK3/530RK3:
CLASS 3R Laser Product

SET230RK/330RK/530RK/630RK:
CLASS 2 Laser Product

CLASS 1 LED Product

OPERATOR'S MANUAL



Li-ion

CONTAINS Li-ion BATTERY.
MUST BE RECYCLED OR DISPOSED OF PROPERLY.

JSIMA :This is the mark of the Japan Surveying Instruments
Manufacturers Association.

SOKKIA

Series30RK

SET230RK/RK3

SET330RK/RK3

SET530RK/RK3

SET630RK

Reflectorless Total Station

SET230RK3/330RK3/530RK3:
CLASS 3R Laser Product

SET230RK/330RK/530RK/630RK:
CLASS 2 Laser Product

CLASS 1 LED Product





OPERATOR'S MANUAL

- Thank you for selecting the SET230RK/230RK3/330RK/330RK3/530RK/530RK3/630RK.
- Please read this operator's manual carefully before using this product.
- Verify that all equipment is included.
☞ "34. STANDARD EQUIPMENT"
- SET has a function to output data saved in the SET to a connected host computer. Command operations from a host computer can also be performed. For details, refer to "Interfacing with the SOKKIA SDR Electronic Field Book" and "Command Explanations" manuals and ask your local dealer.
- The specifications and general appearance of the instrument are subject to change without prior notice and without obligation by Sokkia Topcon Co., Ltd. and may differ from those appearing in this manual.
- The content of this manual is subject to change without notice.
- Some of the diagrams shown in this manual may be simplified for easier understanding.



HOW TO READ THIS MANUAL

Symbols

The following conventions are used in this manual.

-  : Indicates precautions and important items which should be read before operations.
-  : Indicates the chapter title to refer to for additional information.
-  : Indicates supplementary explanation.
-  : Indicates an explanation for a particular term or operation.
- [DIST]** etc. : Indicates softkeys on the display.
- {ESC}** etc. : Indicates operation keys on the SET or wireless keyboard.
- <S-O>** etc. : Indicates screen titles.

Notes regarding manual style

- Except where stated, "SET" means SET230RK/230RK3/330RK/330RK3/530RK/530RK3/630RK in this manual.
- Screens and illustrations appearing in this manual are of SET230RK.
- Location of softkeys in screens used in procedures is based on the factory setting. It is possible to change the allocation of softkeys in Meas mode.
-  What are softkeys: "4.1 Parts of the Instrument", Softkeys allocation: "28.3 Allocating Key Functions"
- Learn basic key operations in "5. BASIC OPERATION" before you read each measurement procedure.
- For selecting options and inputting figures, see "5.1 Basic Key Operation".
- Measurement procedures are based on continuous measurement. Some information about procedures when other measurement options are selected can be found in "Note" ()
- KODAK is a registered trademark of Eastman Kodak Company.
- *Bluetooth*[®] is a registered trademark of Bluetooth SIG, Inc.
- All other company and product names featured in this manual are trademarks or registered trademarks of each respective organization.

READ THIS
FIRST

INTRODUCTION

PREPARATION
FOR
MEASURE-
MENT

MEASURE-
MENT
-MEASURE-
MENT
MODE -

1. PRECAUTIONS FOR SAFE OPERATION	1
2. PRECAUTIONS	5
3. LASER SAFETY INFORMATION	8
4. SET FUNCTIONS	11
4.1 Parts of the Instrument	11
4.2 Mode Diagram	15
5. BASIC OPERATION	16
5.1 Basic Key Operation	16
5.2 Display Functions	19
6. USING THE BATTERY	22
6.1 Battery Charging	22
6.2 Installing/Removing the Battery	23
7. SETTING UP THE INSTRUMENT	25
7.1 Centering	25
7.2 Levelling	26
8. FOCUSING AND TARGET SIGHTING	29
9. POWER ON	31
10. ANGLE MEASUREMENT	32
10.1 Measuring the Horizontal Angle between Two Points (Horizontal Angle 0°)	32
10.2 Setting the Horizontal Angle to a Required Value (Horizontal Angle Hold)	33
10.3 Horizontal Angle Repetition	34
10.4 Angle Measurement and Outputting the Data	35
11. DISTANCE MEASUREMENT	36
11.1 Returned Signal Checking	37
11.2 Distance and Angle Measurement	38
11.3 Recalling the Measured Data	39
11.4 Distance Measurement and Outputting the Data	40
11.5 REM Measurement	41
12. COORDINATE MEASUREMENT	44
12.1 Entering Instrument Station Data and Azimuth Angle	44
12.2 Setting Azimuth Angle from Backsight Coordinates	48
12.3 3-D Coordinate Measurement	50
12.4 Coordinate Measurement and Outputting the Data	52
13. RESECTION MEASUREMENT	53
13.1 Coordinate Resection Measurement	54
13.2 Height Resection Measurement	58

CONTENTS

MEASURE-
MENT
-MEASURE-
MENT
MODE -

14. SETTING-OUT MEASUREMENT	62
14.1 Coordinates Setting-out Measurement	63
14.2 Distance Setting-out Measurement	66
14.3 REM Setting-out Measurement	68
15. SETTING-OUT LINE	70
15.1 Defining Baseline	70
15.2 Setting-out Line Point	75
15.3 Setting-out Line Line	79
16. SETTING-OUT ARC	81
16.1 Defining an Arc	81
16.2 Setting-out Arc	88
17. POINT PROJECTION	92
17.1 Defining Baseline	92
17.2 Point Projection	93
18. INTERSECTIONS	95
19. TRAVERSE ADJUSTMENT	99
20. OFFSET MEASUREMENT	108
20.1 Single-distance Offset Measurement	108
20.2 Angle Offset Measurement	110
20.3 Two-distance Offset Measurement	112
21. MISSING LINE MEASUREMENT	115
21.1 Measuring the Distance between 2 or more Points	115
21.2 Changing the Starting Point	121
22. SURFACE AREA CALCULATION	123
23. RECORDING DATA - RECORD MENU -	128
23.1 Recording Instrument Station Data	128
23.2 Recording Backsight Point	130
23.3 Recording Angle Measurement Data	133
23.4 Recording Distance Measurement Data	134
23.5 Recording Coordinate Data	135
23.6 Recording Distance and Coordinate Data	136
23.7 Recording Notes	137
23.8 Reviewing JOB Data	139
23.9 Deleting Recorded JOB Data	141

MANAGING THE
DATA
-MEMORY
MODE-

24. SELECTING/DELETING A JOB	143
24.1 Selecting a JOB	143
24.2 Deleting a JOB	145
25. REGISTERING/DELETING DATA	147
25.1 Registering/Deleting Known Point Data	147
25.2 Reviewing Known Point Data	150
25.3 Registering/Deleting Codes	151
25.4 Reviewing Codes	152
26. OUTPUTTING JOB DATA	153
27. TRANSFERRING DATA WITH SFX FUNCTION ..	156
27.1 Necessary items	156
27.2 Connecting all equipment	157
27.3 Booting up and quitting SFX	158
27.4 Setting a password	159
27.5 Registering Internet provider information ...	160
27.6 Registering FTP server information	162
27.7 Registering an e-mail address	164
27.8 Sending e-mail (JOB data)	165
27.9 Receiving e-mail with the SET (coordinate data)	166
27.10 FTP server connection (coordinate data/JOB data)	167
27.11 Sending e-mail to the SET	170
27.12 Receiving e-mail from the SET	172
27.13 Troubleshooting	173
28. CHANGING THE SETTINGS	176
28.1 EDM Settings	176
28.2 Configuration -Config Mode-	178
28.3 Allocating Key Functions	184
28.4 Changing Password	187
28.5 Restoring Default Settings	188
29. WIRELESS COMMUNICATION USING <i>BLUETOOTH</i> TECHNOLOGY	190
29.1 Necessary settings for <i>Bluetooth</i> communication	191
29.2 Establishing a connection between the SET and paired <i>Bluetooth</i> device	195
29.3 Measurement using <i>Bluetooth</i> communication .	196
29.4 Registering/Outputting data using <i>Bluetooth</i> com- munication	197

ADDITIONAL
DETAILS

CONTENTS

TROUBLE- SHOOTING

30. WARNING AND ERROR MESSAGES	199
31. CHECKS AND ADJUSTMENTS	205
31.1 Plate Level	205
31.2 Circular Level	206
31.3 Tilt Sensor	207
31.4 Collimation	211
31.5 Reticle	212
31.6 Optical Plummet	214
31.7 Additive Distance Constant	216
31.8 Guide Light	217

INFORMATION ABOUT SET



32. POWER SUPPLIES	221
33. TARGET SYSTEM	223
34. STANDARD EQUIPMENT	225
35. OPTIONAL ACCESSORIES	227
36. SPECIFICATIONS	231
37. EXPLANATION	237
37.1 Manually Indexing the Vertical Circle by Face Left, Face Right Measurement	237
37.2 Atmospheric Correction for High Precision Dis- tance Measurement	238
38. REGULATIONS	240

1. PRECAUTIONS FOR SAFE OPERATION

For the safe use of the product and prevention of injury to operators and other persons as well as prevention of property damage, items which should be observed are indicated by an exclamation point within a triangle used with WARNING and CAUTION statements in this operator's manual.

The definitions of the indications are listed below. Be sure you understand them before reading the manual's main text.

Definition of Indication

 WARNING	Ignoring this indication and making an operation error could possibly result in death or serious injury to the operator.
 CAUTION	Ignoring this indication and making an operation error could possibly result in personal injury or property damage.



This symbol indicates items for which caution (hazard warnings inclusive) is urged. Specific details are printed in or near the symbol.



This symbol indicates items which are prohibited. Specific details are printed in or near the symbol.









This symbol indicates items which must always be performed. Specific details are printed in or near the symbol.





1. PRECAUTIONS FOR SAFE OPERATION

General

Warning









-  Do not use the unit in areas exposed to high amounts of dust or ash, in areas where there is inadequate ventilation, or near combustible materials. An explosion could occur.
 -  Do not perform disassembly or rebuilding. Fire, electric shock, burns or hazardous radiation exposure could result.
 -  Never look at the sun through the telescope. Loss of eyesight could result.
 -  Do not look at reflected sunlight from a prism or other reflecting object through the telescope. Loss of eyesight could result.
 -  Direct viewing of the sun using the telescope during sun observation will cause loss of eyesight. Use solar filter (option) for sun observation.
-  35. OPTIONAL ACCESSORIES
-  When securing the instrument in the carrying case make sure that all catches, including the side catches, are closed. Failure to do so could result in the instrument falling out while being carried, causing injury.

Caution

-  Do not use the carrying case as a footstool. The case is slippery and unstable so a person could slip and fall off it.
 -  Do not place the instrument in a case with a damaged catch, belt or handle. The case or instrument could be dropped and cause injury.
 -  Do not wield or throw the plumb bob. A person could be injured if struck.
-  Secure handle to main unit with locking screws. Failure to properly secure the handle could result in the unit falling off while being carried, causing injury.
 -  Tighten the adjustment tribrach clamp securely. Failure to properly secure the clamp could result in the tribrach falling off while being carried, causing injury.

Power Supply

Warning

-  Do not use voltage other than the specified power supply voltage. Fire or electrical shock could result.
-  Do not use damaged power cords, plugs or loose outlets. Fire or electric shock could result.
-  Do not use power cords other than those designated. Fire could result.
-  Do not place articles such as clothing on the battery charger while charging batteries. Sparks could be induced, leading to fire.
-  Use only the specified battery charger to recharge batteries. Other chargers may be of different voltage rating or polarity, causing sparking which could lead to fire or burns.
-  Do not heat or throw batteries into fire. An explosion could occur, resulting in injury.
-  To prevent shorting of the battery in storage, apply insulating tape or equivalent to the terminals. Otherwise shorting could occur resulting in fire or burns.
-  Do not use batteries or the battery charger if wet. Resultant shorting could lead to fire or burns.
-  Do not connect or disconnect power supply plugs with wet hands. Electric shock could result.





Caution

-  Do not touch liquid leaking from batteries. Harmful chemicals could cause burns or blisters.

1. PRECAUTIONS FOR SAFE OPERATION



Tripod

Caution

-  When mounting the instrument to the tripod, tighten the centering screw securely. Failure to tighten the screw properly could result in the instrument falling off the tripod, causing injury.
-  Tighten securely the leg fixing screws of the tripod on which the instrument is mounted. Failure to tighten the screws could result in the tripod collapsing, causing injury.
-  Do not carry the tripod with the tripod shoes pointed at other persons. A person could be injured if struck by the tripod shoes.
-  Keep hands and feet away from the tripod shoes when fixing the tripod in the ground. A hand or foot stab wound could result.
-  Tighten the leg fixing screws securely before carrying the tripod. Failure to tighten the screws could lead to the tripod legs extending, causing injury.





Wireless Keyboard

Caution

-  Do not perform disassembly or rebuilding. Fire, electric shock or burns could result.
-  Do not use batteries if wet and do not touch batteries with wet hands. Resultant shorting could lead to fire or burns.
-  When changing batteries, follow the procedure described below. If you try to open the battery cover the wrong way or try to force it open, you might injure yourself.

Bluetooth wireless technology

Warning

-  Do not use within the vicinity of hospitals. Malfunction of medical equipment could result.
-  Use the instrument at a distance of at least 22 cm from anyone with a cardiac pacemaker. Otherwise, the pacemaker may be adversely affected by the electromagnetic waves produced and cease to operate as normal.
-  Do not use onboard aircraft. The aircraft instrumentation may malfunction as a result.
-  Do not use within the vicinity of automatic doors, fire alarms and other devices with automatic controls as they may be adversely affected by the electromagnetic waves produced resulting in malfunction and injury.

2. PRECAUTIONS

Tribrach Clamp

- When the instrument is shipped, the tribrach clamp is held firmly in place with a locking screw to prevent the instrument from shifting on the levelling base. Before using the instrument the first time, loosen this screw with a screwdriver. And before transporting it, tighten the locking screw to fasten the tribrach clamp in place so that it will not shift on the levelling base.

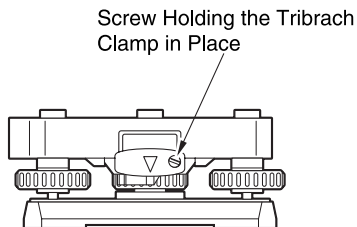

Precautions concerning water and dust resistance

SET conforms to IP64 specifications for waterproofing and dust resistance when the battery cover is closed and connector caps are attached correctly.

- Be sure to close the battery cover and correctly attach the connector caps to protect the SET from moisture and dust particles.
- Make sure that moisture or dust particles do not come in contact with the inside of the battery cover, terminal or connectors. Contact with these parts may cause damage to the instrument.
- Make sure that the inside of the carrying case and the instrument are dry before closing the case. If moisture is trapped inside the case, it may cause the instrument to rust.

The Lithium Battery

The lithium battery, a backup battery which retains data in the internal memory of the SET, can back up data for approximately 5 years of normal use, but its lifetime may be shorter depending on circumstances. Therefore be sure to replace the lithium battery after the instrument has been used for 4 years. Ask our service representative to replace the battery for you. When the lithium battery is replaced, all stored data is cleared. If the voltage supplied by the lithium battery either declines or is completely discharged, the message "Exchange sub bat." is displayed. If the lithium battery completely fails, the data is entirely cleared. We recommend that you store data you must retain to your computer.

Backup data

- Data should be backed up (transferred to an external device etc.) on a regular basis to prevent data loss.

2. PRECAUTIONS

Other precautions

- If the SET is moved from a warm place to an extremely cold place, internal parts may contract and make the keys difficult to operate. This is caused by cold air trapped inside the hermetically sealed casing. If the keys do not depress, open the battery cover to resume normal functionality. To prevent the keys from becoming stiff, remove the connector caps before moving the SET to a cold place.
- Never place the SET directly on the ground. Sand or dust may cause damage to the screw holes or the centering screw on the base plate.
- Do not aim the telescope at the sun. Use the Solar filter to avoid causing internal damage to the instrument when observing the sun.

"35. OPTIONAL ACCESSORIES"

- Protect the SET from heavy shocks or vibration.
- Never carry the SET on the tripod to another site.
- Turn the power off before removing the battery.
- When placing the SET in its case, first remove its battery and place it in the case in accordance with the layout plan.
- Consult your local dealer before using the instrument under special conditions such as long periods of continuous use or high levels of humidity. In general, special conditions are treated as being outside the scope of the product warranty.

Maintenance

- Always clean the instrument before returning it to the case. The lens requires special care. First, dust it off with the lens brush to remove tiny particles. Then, after providing a little condensation by breathing on the lens, wipe it with the wiping cloth.
- If the display is dirty, carefully wipe it with a soft, dry cloth. To clean other parts of the instrument or the carrying case, lightly moisten a soft cloth in a mild detergent solution. Wring out excess water until the cloth is slightly damp, then carefully wipe the surface of the unit. Do not use any organic solvents or alkaline cleaning solutions.
- Store the SET in a dry room where the temperature remains fairly constant.
- Check the tripod for loose fit and loose screws.
- If any trouble is found on the rotatable portion, screws or optical parts (e.g. lens), contact your local dealer.
- When the instrument is not used for a long time, check it at least once every 3 months.

"31. CHECKS AND ADJUSTMENTS"

2. PRECAUTIONS

- When removing the SET from the carrying case, never pull it out by force. The empty carrying case should be closed to protect it from moisture.
- Check the SET for proper adjustment periodically to maintain the instrument accuracy.

- The user of this product is expected to follow all operating instructions and make periodic checks of the product's performance.
- The manufacturer, or its representatives, assumes no responsibility for results of faulty or intentional usage or misuse including any direct, indirect, consequential damage, or loss of profits.
- The manufacturer, or its representatives, assumes no responsibility for consequential damage, or loss of profits due to any natural disaster, (earthquake, storms, floods etc.), fire, accident, or an act of a third party and/or usage under unusual conditions.
- The manufacturer, or its representatives, assumes no responsibility for any damage (change of data, loss of data, loss of profits, an interruption of business etc.) caused by use of the product or an unusable product.
- The manufacturer, or its representatives, assumes no responsibility for any damage, and loss of profits caused by usage different to that explained in the operator's manual.
- The manufacturer, or its representatives, assumes no responsibility for damage caused by incorrect operation, or action resulting from connecting to other products.

3. LASER SAFETY INFORMATION

SET is classified as the following class of Laser Product and LED Product according to IEC Standard Publication 60825-1 Amd. 2: 2001 and United States Government Code of Federal Regulation FDA CDRH 21CFR Part 1040.10 and 1040.11 (Complies with FDA performance standards for laser products except for deviations pursuant to Laser Notice No.50, dated July 26, 2001.)

SET230RK3/330RK3/530RK3

- EDM device in objective lens: Class 3 Laser Product (Class 1 Laser Product when prism or reflective sheet is selected in Config mode as target)
- Guide light (optional function): Class 1 LED Product

SET230RK/330RK/530RK/630RK

- EDM device in objective lens: Class 2 Laser Product (Class 1 Laser Product when prism or reflective sheet is selected in Config mode as target)
- Guide light (optional function): Class 1 LED Product



- EDM device is classified as Class 3R Laser Product (SET230RK3/330RK3/530RK3)/ Class 2 Laser Product (SET230RK/330RK/530RK/630RK) when reflectorless measurement is selected. When the prism or reflective sheet is selected in Config mode as target, the output is equivalent to the safer class 1.
- The guide light is an optional function.
☞ "35. OPTIONAL ACCESSORIES"

⚠ Warning

- Use of controls or adjustments or performance of procedures other than those specified herein may result in hazardous radiation exposure.
- Follow the safety instructions on the labels attached to the instrument as well as in this manual to ensure safe use of this laser and LED product.

SET230RK3/330RK3/530RK3

(On the side of the telescope)



Laser beam is emitted from here

LED beam is emitted from here

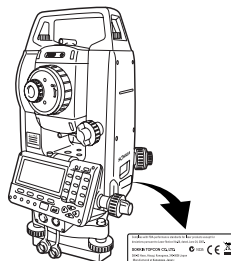

SET230RK/330RK/530RK/630RK

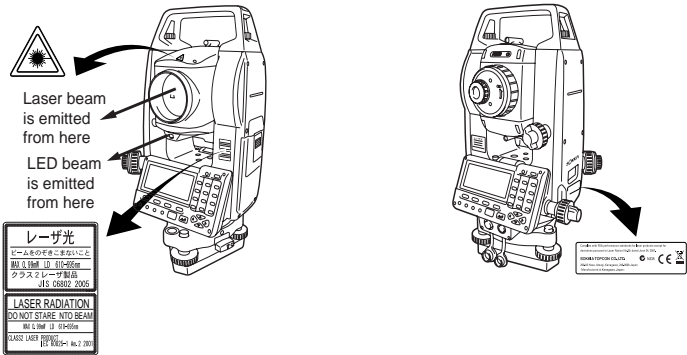

- Never point the laser beam at another person. If the laser beam strikes skin or an eye, it could cause serious injury.
- Do not look directly into the laser beam source. Doing so could cause permanent eye damage.
- Do not stare at the laser beam. Doing so could cause permanent eye damage.
- If an eye injury is caused by exposure to the laser beam, seek immediate medical attention from a licensed ophthalmologist.
- Never look at the laser beam through a telescope, binoculars or other optical instruments. Doing so could cause permanent eye damage. (SET 230RK3/330RK3/530RK3 only)
- Sight the targets so that laser beam does not stray from them. (SET 230RK3/330RK3/530RK3 only)

⚠ Caution

- Perform checks at start of work and periodic checks and adjustments with the laser beam emitted under normal conditions.
- When the instrument is not being used, turn off the power.
- When disposing of the instrument, destroy the battery connector so that the laser beam cannot be emitted.
- Operate the instrument with due caution to avoid injuries that may be caused by the laser beam unintentionally striking a person in the eye. Avoid setting the instrument at heights at which the path of the laser beam may strike pedestrians or drivers at head height.
- Never point the laser beam at mirrors, windows or surfaces that are highly reflective. The reflected laser beam could cause serious injury.

3. LASER SAFETY INFORMATION

- When using the Laser-pointer function, be sure to turn OFF the output laser after distance measurement is completed. Even if distance measurement is canceled, the Laser-pointer function is still operating and the laser beam continues to be emitted. (After turning ON the Laser-pointer, the laser beam is emitted for 5 minutes, and then automatically switches OFF. But in the Status screen and when target symbol (ex. ) is not displayed in the Measurement mode, the laser beam is not automatically turned off.)
- Only those who have been received training as per the following items shall use this product. (SET 230RK3/330RK3/530RK3 only)
 - Read the Operator's manual for usage procedures for this product.
 - Hazardous protection procedures (read this chapter).
 - Requisite protective gear (read this chapter).
 - Accident reporting procedures (stipulate procedures beforehand for transporting the injured and contacting physicians in case there are laser induced injuries).
- Persons working within the range of the laser beam are advised to wear eye protection which corresponds to the laser wavelength of the instrument being used (SET 230RK3/330RK3/530RK3 only).
- Areas in which the lasers are used should be posted with laser warning notices. (SET 230RK3/330RK3/530RK3 only)

4. SET FUNCTIONS

4.1 Parts of the Instrument

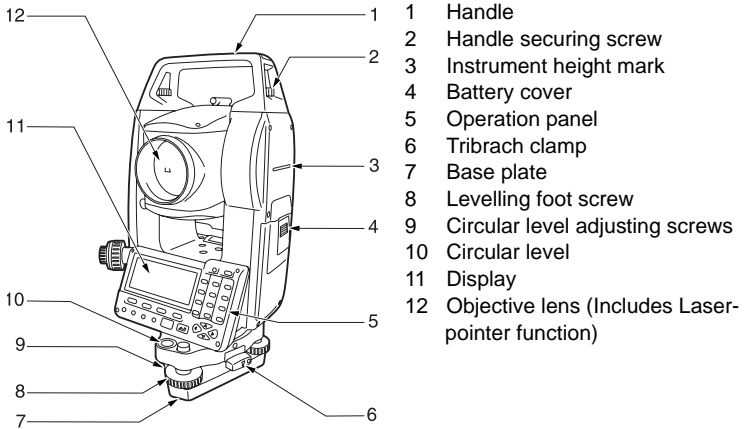

- 1 Handle
- 2 Handle securing screw
- 3 Instrument height mark
- 4 Battery cover
- 5 Operation panel
- 6 Tribrach clamp
- 7 Base plate
- 8 Levelling foot screw
- 9 Circular level adjusting screws
- 10 Circular level
- 11 Display
- 12 Objective lens (Includes Laser-pointer function)

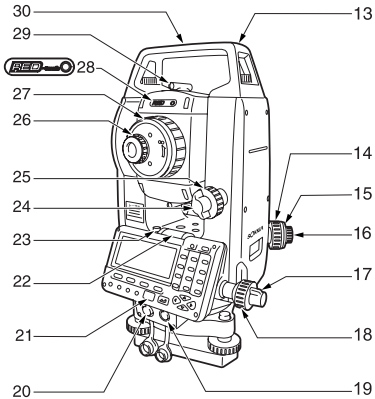

- 13 Tubular compass slot
- 14 Optical plummet focussing ring
- 15 Optical plummet reticle cover
- 16 Optical plummet eyepiece
- 17 Horizontal clamp
- 18 Horizontal fine motion screw
- 19 Data input/output connector (Beside the operation panel on SET630RK)
- 20 External power source connector (Not included on SET630RK)
- 21 Beam detector for wireless keyboard (Not included on SET630RK)
- 22 Plate level
- 23 Plate level adjusting screw
- 24 Vertical clamp
- 25 Vertical fine motion screw
- 26 Telescope eyepiece screw
- 27 Telescope focussing ring
- 28 Laser radiation warning indicator (Not included on SET230RK /330RK/530RK/630RK)
- 29 Peep sight
- 30 Instrument center mark

4. SET FUNCTIONS



Peep sight

Use peep sight to aim the SET in the direction of the measurement point. Turn the instrument until the triangle in the peep sight is aligned with the target.



Instrument height mark

The height of the SET is 236mm (from tribrach dish to this mark). "Instrument height" is input when setting instrument station data and is the height from the measuring point (where SET is mounted) to this mark.



Laser-pointer Function

A target can be sighted with a red laser beam in dark locations without the use of the telescope.

Operation panel

5.1 Basic Key Operation"

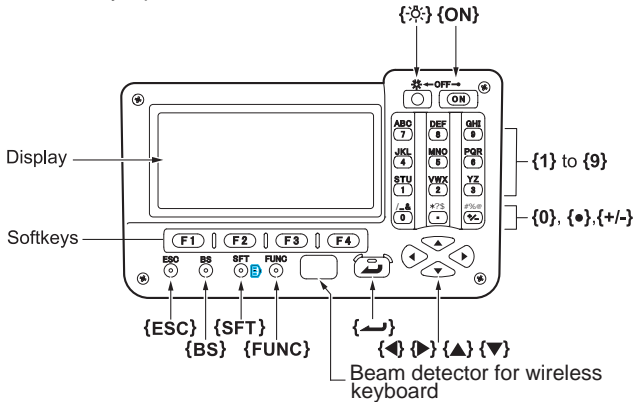

Laser radiation warning indicator (only SET230RK3/330RK3/530RK3)

Laser radiation warning indicator is red when laser beam is emitted or laser-pointer is used, and laser beam status can be known from the telescope eyepiece side.

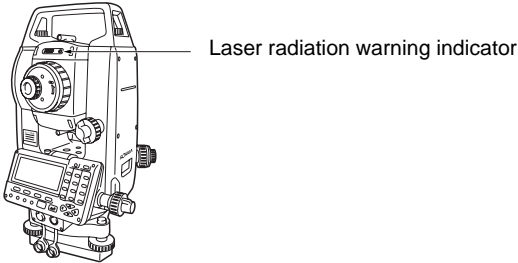

Wireless keyboard (Optional accessory)

☞ "35. OPTIONAL ACCESSORIES"



- Wireless keyboard cannot be used on SET630RK.

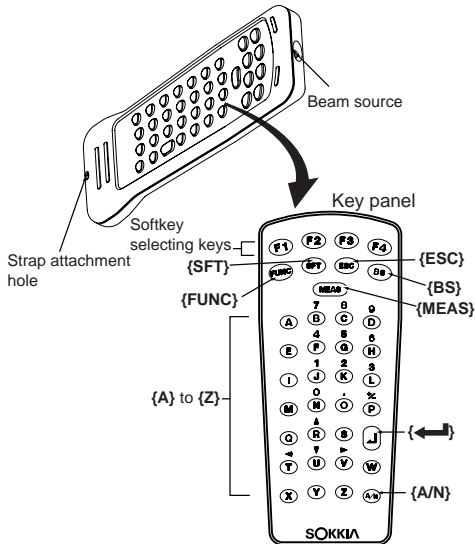

4. SET FUNCTIONS

Guide light (Optional function)

 "35. OPTIONAL ACCESSORIES"

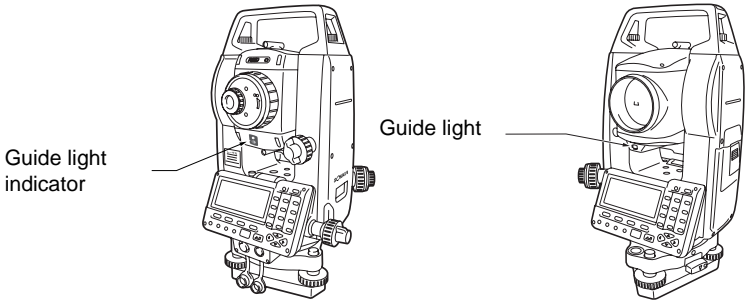

Guide light and Guide light indicator

Setting-out measurement etc. can be carried out effectively using the Guide light. The Guide light is composed of a light that is divided into a red and a green light. A poleman can ascertain the present position by checking the Guide light color.

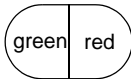

Guide light status

Light status	Meaning
Red	(From position of poleman) Move target left
Green	(From position of poleman) Move target right
Red and Green	Target is at correct horizontal position

The Guide light indicator is lit when the Guide light is ON.

4.2 Mode Diagram

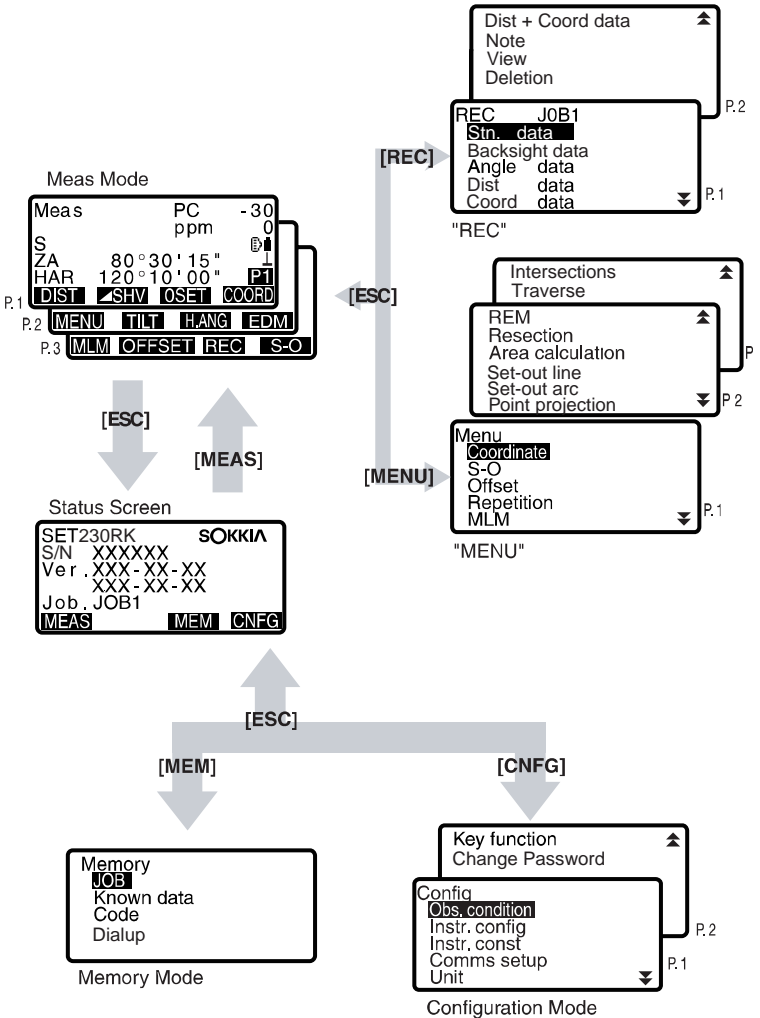

5. BASIC OPERATION

5.1 Basic Key Operation

Learn basic key operations here before you read each measurement procedure.

 Location of operation keys on the panel and Location of operation keys on the wireless keyboard : "4.1 Parts of the Instrument"

- Wireless keyboard (SF14) (Optional accessory) makes key operation easier and speedier.

 Specification of the keyboard: "35. OPTIONAL ACCESSORIES"

● Power ON / OFF

{ON}	Power On
{ON} (while pressing)+ 	Power Off

● Lighting up the display and key

	Switch the screen/key backlight On / Off
--	--

● Switching target type

Target type can be switched only on the screen where the target symbol (ex. ) is displayed.

{SFT}	Switches between target types (Prism/Sheet/None(reflectorless))
-------	---

 Target symbol displayed: "5.2 Display Functions", Switching the target type in Config mode": "28.1 EDM Settings"

● Switching the Laser-pointer/Guide light (optional function) ON/OFF

 (Press and hold)	To turn the laser-pointer/guide light ON/OFF, press and hold until a beep sounds.
--	---

 Selecting of laser-pointer/guide light (optional function) : "28.1 EDM Settings"

Note

- After turning ON the laser-pointer/guide light, the laser beam is emitted for 5 minutes, and then automatically switches OFF. But in the Status screen and when target symbol (ex. ) is not displayed in the Meas mode, the laser beam is not automatically turned off.

● Softkey operation

Softkeys are displayed on the bottom line of the screen.

{F1} to {F4}	Select the function matching the softkeys
{FUNC}	Toggle between Meas mode screen pages (when more than 4 softkeys are allocated)

● Inputting letters/figures

{SFT}	Switch between numeric and alphabetic characters.
{0} to {9}	During numeric input, input number of the key. During alphabetic input, input the characters displayed above the key in the order they are listed.
{.}/{±}	Input a decimal point/plus or minus sign during numeric input. During alphabetic input, input the characters displayed above the key in the order they are listed.
{◀}/{▶}	Right and left cursor/Select other option.
{ESC}	Cancel the input data.
{BS}	Delete a character on the left.
{←}	Select/accept input word/value.

Example :Entering "JOB M" in the JOB name field

1. Press **{SFT}** to enter the alphabet input mode
Alphabet input mode is indicated by an "A" on the right of the screen.
2. Press **{4}**.
"J" is displayed.
3. Press **{5}** three times.
"O" is displayed.
4. Press **{7}** twice.
"B" is displayed.
5. Press **{▶}** once.
Input a blank space.

5. BASIC OPERATION

6. Press {5} once.
"M" is displayed. Press {←} to complete inputting.

```
JOB name edit
JOB M
```

● Selecting options

{▲}/{▼}	Up and down cursor
▶/◀	Right and left cursor/Select other option
{←}	Accept the option

Example: Select a reflector type

1. Press [EDM] in page 2 of Meas mode.
2. Move to "Reflector" using {▲}/{▼}.

3. Display the option you want to select using ▶/◀.
Switches between "Prism", "Sheet" and "None."

```
EDM
Mode : Fine "r"
Reflector: Prism
PC : - 30
Illum.hold: Laser
```

4. Press {←} or {▼} to move to the next option.
The selection is set and you can set the next item.

● Switching modes

[CNFG]	From Status mode to Config Mode (Configuration Mode)
[MEAS]	From Status mode to Meas Mode (Measurement Mode)
[MEM]	From Status mode to Memory Mode
{ESC}	Return to the Status mode from each Mode

☞ "4.2 Mode Diagram"

● Other operation

{ESC}	Return to the previous screen
-------	-------------------------------

5.2 Display Functions

Status screen

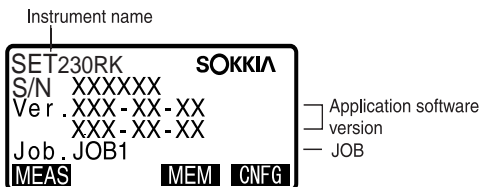

Meas Mode screen

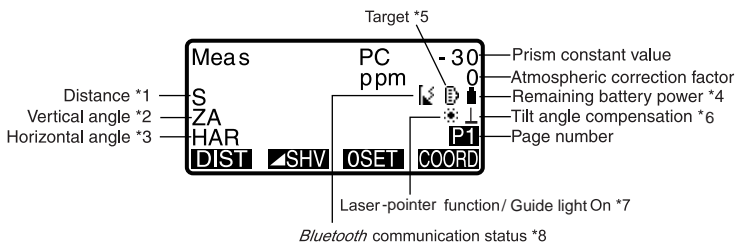

Measuring screen

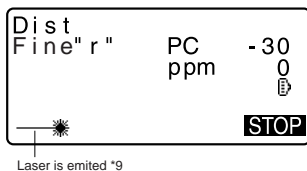

Input screen

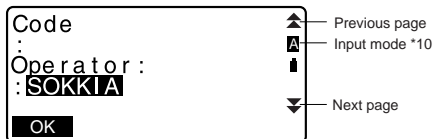

5. BASIC OPERATION

* 1 Distance

 Switching distance display status: "28.2 Configuration -Config Mode-"
S : Slope distance
H : Horizontal distance
V : Height difference

* 2 Vertical angle

 Switching vertical angle display status: "28.2 Configuration -Config Mode-"
ZA : Zenith angle (Z=0)
VA : Vertical angle (H=0/H=±90)

To switch vertical angle/slope in %, press **[ZA/%]**

* 3 Horizontal angle

Press **[R/L]** to switch the display status.

HAR: Horizontal angle right

HAL: Horizontal angle left

* 1,2,3

To switch usual "S, ZA, HAR" display to "S, H, V", press **[▲ SHV]**.

* 4 Remaining battery power (BDC46B, Temperature=25°C, EDM on)

 : level 3 Full power.

 : level 2 Plenty of power remains.

 : level 1 Half or less power remains.

 : level 0 Little power remains. Charge the battery.

 (This symbol is displayed every 3 seconds): No power remains.

Stop the measurement and charge the battery.

 "6. USING THE BATTERY"

*5 Target display

Press **{SFT}** to switch the selected target. This key function can be used only on the screens on which the target symbol is displayed.

 :prism

 :reflective sheet



 :reflectorless

* 6 Tilt angle compensation









When this symbol is displayed, the vertical and horizontal angles are automatically compensated for small tilt errors using 2-axis tilt sensor.

 Tilt compensation setting: "28.2 Configuration -Config Mode-"

*7 Laser-pointer/Guide light (optional function) display



-  Selecting Laser-pointer/Guide light: "28.1 EDM Settings", Switching Laser-pointer/Guide light ON/OFF : "5.1 Basic Key Operation"
-  :Laser-pointer is selected and ON
-  :Guide light is selected and ON

*8 Bluetooth communication status

- : Connection established ("Mode" is set to "Slave")
- : Connection established ("Mode" is set to "Master")
-  (flashing): Connecting ("Mode" is set to "Slave")
-  (flashing): Connecting ("Mode" is set to "Master")
-  (flashing): Waiting
-  (flashing): Disconnecting ("Mode" is set to "Slave")
-  (flashing): Disconnecting ("Mode" is set to "Master")
- : *Bluetooth* device is OFF ("Mode" is set to "Slave")
- : *Bluetooth* device is OFF ("Mode" is set to "Master")

*9 Appears when laser beam is emitted for distance measurement

*10 Input mode

-  :Inputting capital letters and figures.
-  :Inputting small letters and figures.

6. USING THE BATTERY

6.1 Battery Charging

The battery has not been charged at the factory.



- Do not short circuit. Heat or ignition could result.
- Batteries cannot be charged, even when the charging lamp is flashing, when the temperature is outside the charging temperature range. Always charge batteries within the charging temperature range.
- Do not leave the battery in places exposed to high temperatures (more than 35°C). Doing so may reduce the life of the battery.
- Charge the battery once a month to maintain its quality when not in use for long periods.
- Do not charge the battery just after charging is completed. Battery performance may decline.
- Do not use to charge batteries other than those specified.
- If you allow the battery level to get too low, the battery may not be rechargeable or operating time may decline. Keep the battery always charged.
- The charger will become rather hot during use. This is normal.

►PROCEDURE

1. Connect the power cable to the CDC68 charger and plug the charger into the wall outlet.
2. Mount the battery (BDC46B) in the charger (CDC68) by matching the grooves on the battery with the guides on the charger. When charging starts, the lamp starts blinking.
3. Charging takes approximately 2.5 hours (25°C). The lamp lights when charging is finished.
4. Remove the battery and unplug the charger.

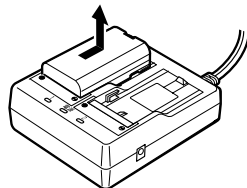
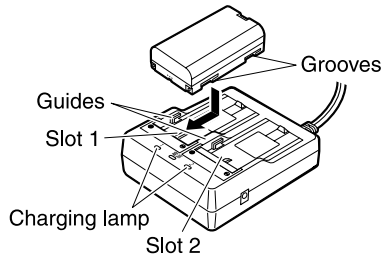



- Slots 1 and 2: The charger starts charging the battery mounted first. If you place two batteries in the charger, the battery in slot 1 is charged first, and then the battery in slot 2. (step 2)
- Charging lamp: The charging lamp is off when the charger is outside the charging temperature range or when the battery is mounted incorrectly. If the lamp is still off after the charger falls within its charging temperature range and the battery is mounted again, contact your local dealer. (steps 2 and 3)
- Charging time: Charging can take more than 2.5 hours when temperatures are either especially high or low.

6.2 Installing/Removing the Battery

Mount the charged battery.



- When removing the battery, turn the power off.
- When installing/removing the battery, make sure that moisture or dust particles do not come in contact with the inside of the instrument.

► PROCEDURE

1.

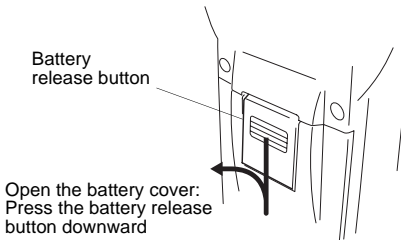

6. USING THE BATTERY

2.

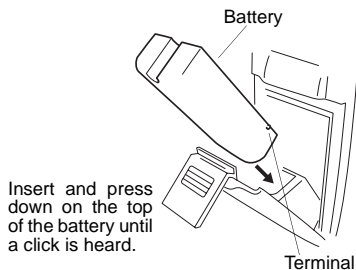

3.

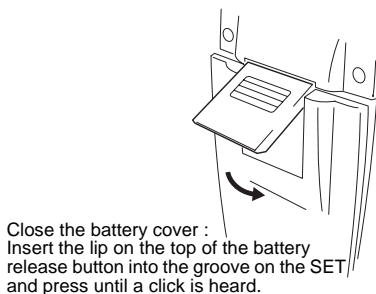

Note

4. Battery cover

If the battery cover is open during power on, SET notifies you by displaying the screen below and beeping.

When the battery cover is closed, the previous screen is restored.

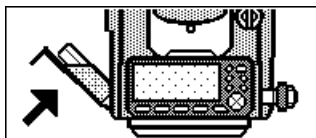

7. SETTING UP THE INSTRUMENT



- Mount the battery in the instrument before performing this operation because the instrument will tilt slightly if the battery is mounted after levelling.

7.1 Centering

► PROCEDURE

1. Make sure the legs are spaced at equal intervals and the head is approximately level.

Set the tripod so that the head is positioned over the survey point. Make sure the tripod shoes are firmly fixed in the ground.

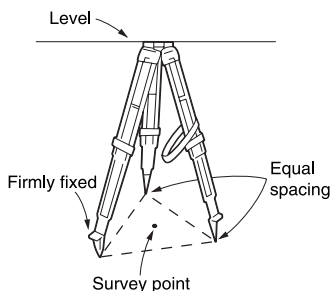

2. Place the instrument on the tripod head.

Supporting it with one hand, tighten the centering screw on the bottom of the unit to make sure it is secured to the tripod.

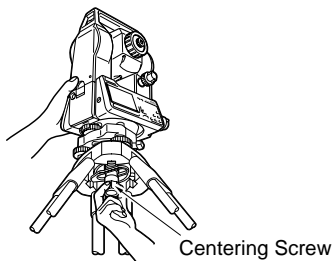

3. Looking through the optical plummet eyepiece, turn the optical plummet eyepiece to focus on the reticle.

Turn the optical plummet focusing ring to focus on the survey point.

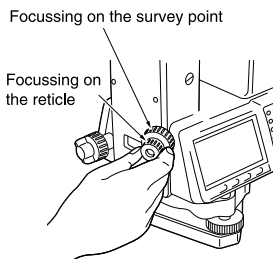

7. SETTING UP THE INSTRUMENT

7.2 Levelling

Instrument can be levelled using the screen.

 **Note** Levelling on the screen”

► PROCEDURE

1. Adjust the levelling foot screws to center the survey point in the optical plummet reticle.
2. Center the bubble in the circular level by either shortening the tripod leg closest to the offcenter direction of the bubble or by lengthening the tripod leg farthest from the offcenter direction of the bubble. Adjust one more tripod leg to center the bubble.

Turn the levelling foot screws while checking the circular level until the bubble is centered in the center circle.

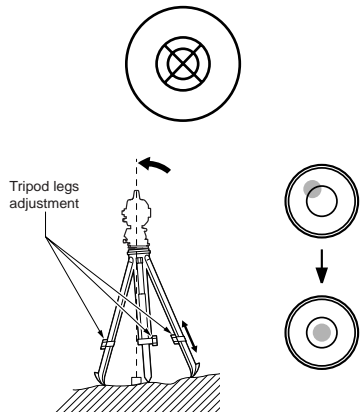

3. Loosen the horizontal clamp to turn the upper part of the instrument until the plate level is parallel to a line between levelling foot screws A and B. Center the air bubble using levelling foot screws A and B simultaneously. The bubble moves towards a clockwise rotated levelling foot screw.

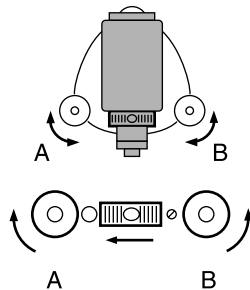

7. SETTING UP THE INSTRUMENT

- Turn the upper part of the instrument through 90° . The plate level is now perpendicular to a line between levelling foot screws A and B. Center the air bubble using levelling foot screw C.

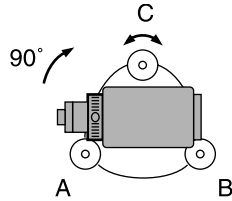

- Turn the upper part of the instrument a further 90° and check to see if the bubble is still in the center of the plate level. If the bubble is off-center, perform the following:
 - Turn levelling foot screws A and B equally in opposite directions to remove half of the bubble displacement.
 - Turn the upper part a further 90° , and use levelling foot screw C to remove half of the displacement in this direction.

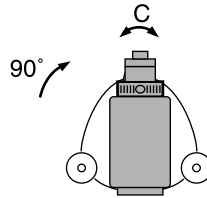

Or adjust the plate level.

 "31.1 Plate Level"

- Turn the instrument and check to see if the air bubble is in the center position in all directions. If it is not, repeat the levelling procedure.
- Loosen the centering screw slightly. Looking through the optical plummet eyepiece, slide the instrument over the tripod head until the survey point is exactly centered in the reticle. Retighten the centering screw securely.

7. SETTING UP THE INSTRUMENT

- Check again to make sure the bubble in the plate level is centered
If not, repeat the procedure starting from step 3.

►PROCEDURE Levelling on the screen

- Press **{ON}** to power on
- Press **[TILT]** in the second page of Meas Mode to display the circular level on the screen.
“●” indicates bubble in circular level. The range of the inside circle is $\pm 4'$ and the range of the outside circle is $\pm 6'$.
Tilt angle values X and Y are also displayed on the screen.
- Center “●” in the circular level
 "7.2 Levelling" steps 1 to 2

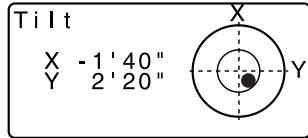

- Turn the instrument until the telescope is parallel to a line between levelling foot screws A and B, then tighten the horizontal clamp.
- Set the tilt angle to 0° using foot screws A and B for the X direction and levelling screw C for the Y direction.
- When levelling is completed, press **{ESC}**.

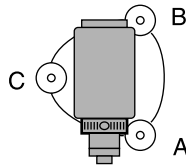

8. FOCUSING AND TARGET SIGHTING



- When sighting the target, strong light shining directly into the objective lens may cause the instrument to malfunction. Protect the objective lens from direct light by attaching the lens hood.
Observe to the same point of the reticle when the telescope face is changed.

►PROCEDURE

1. Look through the telescope eyepiece at a bright and featureless background. Turn the eyepiece screw clockwise, then counterclockwise little by little until just before the reticle image becomes focussed. Using these procedures, frequent reticle refocussing is not necessary since your eye is focussed at infinity.
2. Loosen the vertical and horizontal clamps, then use the peep sight to bring the target into the field of view. Tighten both clamps.
3. Turn the telescope focussing ring to focus on the target. Turn the vertical and horizontal fine motion screws to align the target with the reticle. The last adjustment of each fine motion screw should be in the clockwise direction.

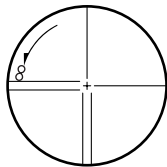

8. FOCUSING AND TARGET SIGHTING

4. Readjust the focus with the focussing ring until there is no parallax between the target image and the reticle.



Eliminating parallax

This is the relative displacement

of the target image with respect to the reticle when the observer's head is moved slightly before the eyepiece.

Parallax will introduce reading errors and must be removed before observations are taken. Parallax can be removed by refocussing the reticle.

9. POWER ON

☞ Setting "V manual": "28.2 Configuration -Config Mode-", Setting/changing password: "28.4 Changing Password"

►PROCEDURE

1. Press {ON}.

When the power is switched on, a self-check is run to make sure the instrument is operating normally.

- When password is set, the display appears as at right. Input password and press {←}.

- When "V manual" is set to "Yes", the display appears as at right.

☞ Manually indexing the vertical circle by face left, face right measurements:

"37. EXPLANATION"

0 Set
Take F1
ZA V1
HAR 0°00'00"
OK

After that, Meas Mode screen appears.

Meas PC -30
ppm 0
S
ZA 80°30'15"
HAR 120°10'00"
P1
DIST SHV OSET COORD

If "Out of range" is displayed, the instrument tilt sensor is indicating that the instrument is out of level. Level the instrument once again and the horizontal and vertical angles will be displayed.

Note

- When "Resume" in "Instr. config" is set to "On", the screen previous to power off is displayed (except when missing line measurement was being performed).
☞ "28.2 Configuration -Config Mode-"
- "Tilt crn" in "Obs. condition" should be set to "No" if the display is unsteady due to vibration or strong wind.
☞ "28.2 Configuration -Config Mode-"

10. ANGLE MEASUREMENT

This section explains the procedures for basic angle measurement.

10.1 Measuring the Horizontal Angle between Two Points (Horizontal Angle 0°)

Use the "OSET" function to measure the included angle between two points. The horizontal angle can be set to 0 at any direction.

► PROCEDURE

1. Sight the first target as at right.

1st target

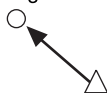

Instrument Station

2. In the first page of the Meas mode screen, press **[OSET]**.

[OSET] will flash, so press **[OSET]** again.

The horizontal angle at the first target becomes 0°.

Meas	PC	-30
	ppm	0
S		
ZA	89°59'50"	
HAR	0°00'00"	P1
DIST		OSET COORD

3. Sight the second target.

2nd Target



The displayed horizontal angle (HAR) is the included angle between two points.

Meas	PC	-30
	ppm	0
S		
ZA	89°59'50"	
HAR	117°32'20"	P1
DIST		OSET COORD

10.2 Setting the Horizontal Angle to a Required Value (Horizontal Angle Hold)

You can reset the horizontal angle to a required value and use this value to find the horizontal angle of a new target.

► PROCEDURE

1. Sight the first target.
2. In the second page of the Meas mode screen, press **[H.ANG]**. Select "Angle".
3. Enter the angle you wish to set, then press **[OK]**. The value that is input as the horizontal angle is displayed.
 - When **[REC]** is pressed, backsight angle can be set and recorded in the current JOB.  "23.2 Recording Backsight Point"
4. Sight the second target. The horizontal angle from the second target to the value set as the horizontal angle is displayed.

Set H angle	
Take BS	
ZA	89° 59' 50"
HAR	347° 23' 46"
HAR:	125.3220
REC	OK

Meas	PC	- 30
	ppm	0
S		
ZA	89° 59' 50"	
HAR	125° 32' 20"	P1
DIST	SHV	OSET COORD

Note

- Pressing **[HOLD]** performs the same function as above.
- Press **[HOLD]** to set the displayed horizontal angle. Then, set the angle that is in hold status to the direction you require.  Allocating **[HOLD]**: "28.3 Allocating Key Functions"

10. ANGLE MEASUREMENT

10.3 Horizontal Angle Repetition

To find the horizontal angle with greater precision, perform repetition measurement.

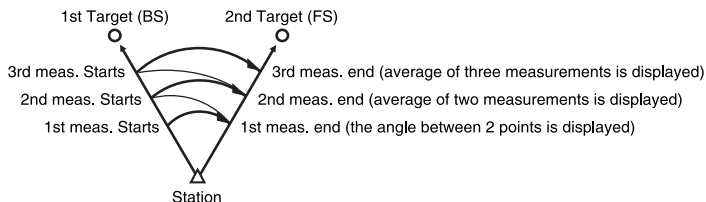

- The maximum number of angle measurements that can be made is 10.

► PROCEDURE

1. In the second page of Meas mode screen, press **[MENU]**, then select "Repetition".

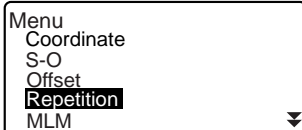

2. Sighting the first target, press **[OK]**.

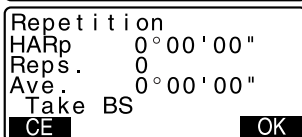

3. Sighting the second target, press **[OK]**.

4. Sighting the first target a second time, press **[OK]**.

5. Sighting the second target a second time, press **[OK]**.
The added value of the horizontal angle is displayed on the second line "HARp" and the average value of the horizontal angle is displayed on the fourth line "Ave.".

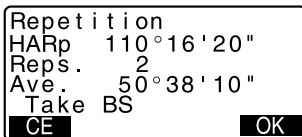

- Return to the previous measurement of the first target and redo it: **[CE]**.
(Effective when the display shows "Take BS")
6. When continuing the repetition measurement, repeat steps 4 to 5.
 7. When the repetition measurement is completed, press **{ESC}**.

Note

- It is also possible to perform repetition measurement by pressing **[REP]** when allocated to the Meas mode screen.
 Allocating **[REP]**: "28.3 Allocating Key Functions"

10.4 Angle Measurement and Outputting the Data

The following explains angle measurement and the features used to output measurement data to a computer or peripheral equipment.

-  Communication cables: "35. OPTIONAL ACCESSORIES"
Output format and command operations: "Interfacing with the SOKKIA SDR Electronic Field Book" and "Command Explanations" manuals.

► PROCEDURE

1. Connect SET and host computer.
2. Allocate the **[D-OUT]** softkey to the Meas mode screen.
 "28.3 Allocating Key Functions"
3. Sight the target point.
4. Press **[D-OUT]** and select "Angle Data".
Output measurement data to peripheral equipment.

11. DISTANCE MEASUREMENT

Perform the following settings as preparation for distance measurement.

- Distance measurement mode
- Target type
- Prism constant correction value
- Atmospheric correction factor
- EDM ALC

 "28.1 EDM Settings"/"28.2 Configuration -Config Mode-"

CAUTION

- When using the Laser-pointer function, be sure to turn OFF the output laser after distance measurement is completed. Even if distance measurement is canceled, the Laser-pointer function is still operating and the laser beam continues to be emitted. (After turning ON the Laser-pointer, the laser beam is emitted for 5 minutes, and then automatically switches OFF. But in the Status screen and when target symbol (ex. ) is not displayed in the Meas mode, the laser beam is not automatically turned off.)



- Make sure that the target setting on the instrument matches the type of target used. SET automatically adjusts the intensity of the laser beam and switches the distance measurement display range to match the type of target used. If the target does not correspond to the target settings, accurate measurement results cannot be obtained.
- Accurate measurement results cannot be obtained if the objective lens is dirty. Dust it off with the lens brush first, to remove minute particles. Then, after providing a little condensation by breathing on the lens, wipe it off with the wiping cloth.
- During reflectorless measurement, if an object with a high reflective factor (metal or white surface) is positioned between the SET and the target, accurate measurement results may not be received.
- Scintillation may affect the accuracy of distance measurement results. Should this occur, repeat measurement several times and use the averaged value of the obtained results.

11.1 Returned Signal Checking

- Check to make sure that sufficient reflected light is returned by the reflective prism sighted by the telescope. Checking the returned signal is particularly useful when performing long distance measurements.



- When the light intensity is sufficient even though the center of the reflective prism and the reticle are slightly misaligned (short distance etc.), "*" will be displayed in some cases, but in fact, accurate measurement is impossible. Therefore make sure that the target center is sighted correctly.

► PROCEDURE

1. Allocate the **[AIM]** softkey to the Meas mode screen.
 "28.3 Allocating Key Functions"
2. Accurately sight the target.
3. Press **[AIM]**.
 <Aiming> is displayed.
 The intensity of the light of the returned signal is displayed by a gauge.

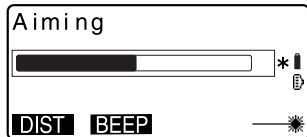

- The more  displayed, the greater the quantity of reflected light.
- If "*" is displayed, only enough light for the measurement is returned.
- When "*" is not displayed, accurately resight the target. Press **[BEEP]** to make a buzzer sound when measurement is possible. Press **[OFF]** to shut off the buzzer.
- Press **[DIST]** to start distance measurement.

11. DISTANCE MEASUREMENT

- Press **{ESC}** to finish signal checking and return to Meas Mode.

Note

- When ██████████ is displayed persistently, contact your local dealer.
- If no key operations are performed for two minutes, the display automatically returns to the Meas mode screen.

11.2 Distance and Angle Measurement

An angle can be measured at the same time as the distance.

► PROCEDURE

- Sight the target.
- In the first page of Meas Mode, press **[DIST]** to start distance measurement.

Meas	PC	-30
	ppm	0
S		
ZA	80°30'15"	
HAR	120°10'00"	P1
DIST	SHV	OSET COORD

When measurement starts, EDM information (distance mode, prism constant correction value, atmospheric correction factor) is represented by a flashing light.

Dist	PC	-30
Fine" r "	ppm	0
		STOP

A short beep sounds, and the measured distance data (S), vertical angle (ZA), and horizontal angle (HAR) are displayed.

Meas	PC	-30
	ppm	0
S	525.450m	
ZA	80°30'10"	
HAR	120°10'00"	P1
		STOP

3. Press **[STOP]** to quit distance measurement.

- Each time **[▲SHV]** is pressed, S (Slope distance), H (Horizontal distance) and V (Height difference) are displayed alternately.

Meas	PC	- 30
	ppm	0
S	525.450m	
H	518.248m	
V	86.699m	P1
[DIST]	[▲SHV]	[OSET] [COORD]

Note

- If the single measurement mode is selected, measurement automatically stops after a single measurement.
- During fine average measurement, the distance data is displayed as S-1, S-2, ... to S-9. When the designated number of measurements has been completed, the average value of the distance is displayed in the [S-A] line.
- The distance and angle that are most recently measured remain stored in the memory until the power is off and can be displayed at any time.
 "11.3 Recalling the Measured Data"

11.3 Recalling the Measured Data

The distance and angle that are most recently measured remain stored in the memory until the power is off and can be displayed at any time.

The distance measurement value, vertical angle, horizontal angle, and the coordinates can be displayed. Distance measurement values converted into the horizontal distance, elevation difference, and the slope distance can also be displayed.

► PROCEDURE

- Allocate the **[RCL]** softkey to the Meas mode screen.
 "28.3 Allocating Key Functions"

11. DISTANCE MEASUREMENT

2. Press **[RCL]**.

The stored data that is most recently measured is displayed.

- If you have pressed **[▲SHV]** beforehand, the distance values are converted into the horizontal distance, elevation difference, and the slope distance and recalled.

S	525.450m
ZA	80°30'10"
HAR	120°10'10"
N	-128.045
E	-226.237
Z	30.223

3. Press **{ESC}** to return to Meas mode.

11.4 Distance Measurement and Outputting the Data

The following explains distance measurement and the features used to output measurement data to a computer or peripheral equipment.

 Communication cables: "35. OPTIONAL ACCESSORIES"

Output format and command operations: "Interfacing with the SOKKIA SDR Electronic Field Book" and "Command Explanations" manuals.

► PROCEDURE

1. Connect SET and host computer.
2. Allocate the **[D-OUT]** softkey to the Meas mode screen.
 "28.3 Allocating Key Functions"
3. Sight the target point.
4. Press **[D-OUT]**, and select "Dist data" to measure the distance and output the data to peripheral equipment.
5. Press **[STOP]** to stop outputting data and return to Meas Mode.

11.5 REM Measurement

An REM measurement is a function used to measure the height to a point where a target cannot be directly installed such as power lines, overhead cables and bridges, etc.

The height of the target is calculated using the following formula.

$$H_t = h_1 + h_2$$

$$h_2 = S \sin \theta_{z1} \times \cot \theta_{z2} - S \cos \theta_{z1}$$

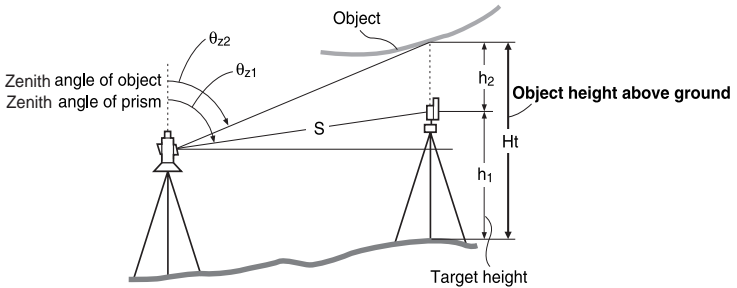

► PROCEDURE

1. Set the target directly under or directly over the object and measure the target height with a tape measure etc.

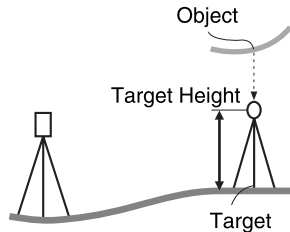

2. After inputting the target height, accurately sight the target.



Press **[DIST]** in page 1 of Meas Mode to carry out measurement.

The measured distance data (S), vertical angle (ZA), and horizontal angle (HAR) are displayed.

Press **[STOP]** to stop the measurement.

11. DISTANCE MEASUREMENT

3. In the second page of Meas mode screen, press **[MENU]**, then select "REM".

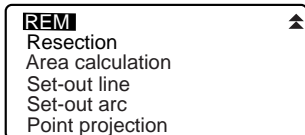

4. Press **[OBS]**. The REM measurement is started and the height from the ground to the object is displayed in "Ht.".

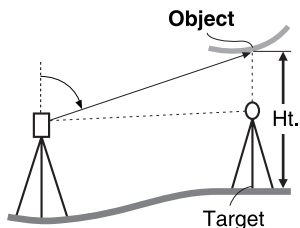
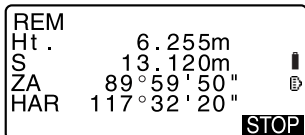
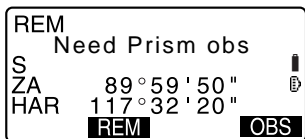

5. Press **[STOP]** to terminate the measurement operation.

- To re-observe the target, sight the target, then press **[OBS]**.
- When **[REC]** is pressed, REM data is saved.

"23. RECORDING DATA - RECORD MENU -"

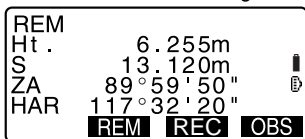

6. Press **{ESC}** to finish measurement and return to the Meas mode screen.

Note

- It is also possible to perform REM measurement by pressing **[REM]** when allocated to the Meas mode screen.

☞ "28.3 Allocating Key Functions"

- Inputting instrument and target height: Press **[HT]** to set instrument and target height. It can be set also in "Strn. Orientation" of coordinate measurement.

☞ "12.1 Entering Instrument Station Data and Azimuth Angle"

12. COORDINATE MEASUREMENT

By performing coordinate measurements it is possible to find the 3-dimensional coordinates of the target based on station point coordinates, instrument height, target height, and azimuth angles of the backsight station which are entered in advance.

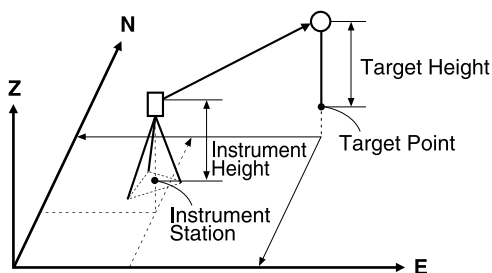

- EDM setting can be done in coordinate measurement menu.
☞ Setting items: "28.1 EDM Settings"

12.1 Entering Instrument Station Data and Azimuth Angle

Before coordinate measurement, enter instrument station coordinates, the instrument height, target height, and azimuth angle.

► PROCEDURE

1. First measure the target height and instrument height with a tape measure, etc.
2. Press **[COORD]** in the first page of the Meas mode screen to display <Coord.>.

3. Select "Stn. Orientation".
 Input the following data items.
- (1) Instrument station coordinates
 - (2) Point number
 - (3) Instrument height
 - (4) Code
 - (5) Operator
 - (6) Date
 - (7) Time
 - (8) Weather
 - (9) Wind
 - (10) Temperature
 - (11) Air pressure
 - (12) Atmospheric correction factor

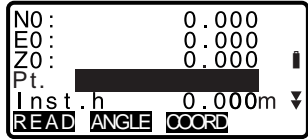
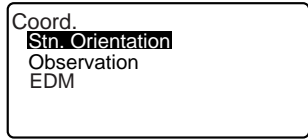

4. Press **[ANGLE]** in the screen of step 3 to proceed to azimuth angle input.

- Press **[COORD]** to calculate azimuth angle from backsight coordinates.
- "12.2 Setting Azimuth Angle from Backsight Coordinates"

- When you wish to read in the registered coordinate data, press **[READ]**.
- "PROCEDURE Reading in Registered Coordinate Data"

5. Input azimuth angle and press **[OK]** to set the input values.
 <Coord> is displayed again.

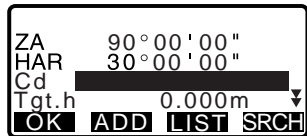

- Press **[REC]** to record code, target height, and point number values. Press **[OK]** to set the input values and return to <Coord>.

12. COORDINATE MEASUREMENT

Note

- Maximum point number size: 14 (alphanumeric)
- Input range of instrument height: -9999.999 to 9999.999 (m)
- Maximum code/operator size: 16 (alphanumeric)
- Weather selection: Fine, Cloudy, Light rain, Rain, Snow
- Wind selection: Calm, Gentle, Light, Strong, Very strong
- Temperature range: -30 to 60 (°C) (in 1°C step)/-22 to 140 (°F) (in 1°F step)
- Air pressure range: 500 to 1400 (hPa) (in 1 hPa step)/375 to 1050 (mmHg) (in 1mmHg step)/14.8 to 41.3 (inch Hg) (in 0.1 inch Hg step)
- Atmospheric correction factor range (ppm): -499 to 499

► PROCEDURE Reading in Registered Coordinate Data

Known point data, coordinate data and instrument station data in the current JOB and Coordinate Search JOB can be read in.

Confirm that the correct JOB containing the coordinates you want to read in is already selected in Coordinate Search JOB in Memory Mode.

 "25.1 Registering/Deleting Known Point Data", "24.1 Selecting a JOB"

1. Press **[READ]** when setting Instrument Station.
The list of registered coordinates is displayed.

Pt. : Known point data saved in the current JOB or in the Coordinate Search JOB.

Crd./ Stn : Coordinate data saved in the current JOB or in the Coordinate Search JOB.

Pt .	11111111	▲
Pt .	1	
Crd .	2	
Stn	12345679	
Stn	1234	▼
[↓·P]	[TOP]	[LAST] [SRCH]

2. Align the cursor with the required point number and press **{←}**.
The point number that was read and its coordinates in are displayed.

NO :	370.000	
EO :	10.000	
ZO :	100.000	■
Pt .	PNT-001	
Inst . h	0.000	m▼
	[ANGLE]	[COORD]

- [**↑↓...P**] = Use {**▲**}/{**▼**} to move from page to page.
- [**↑↓...P**] = Use {**▲**}/{**▼**} to select individual point.
- Press [**TOP**] to move to the first point number on the first page.
- Press [**LAST**] to move to the last point number on the last page.
- Press [**SRCH**] to move to the "Coordinate Data Search Screen." Input the point number you want to search in "Pt. no." The search may take time if many data are registered.

3. Press [**OK**].

<Instrument Station Data Setting>
is restored.

- You can edit the coordinate data that was read in. Editing does not affect the original coordinate data. After editing, the point number is no longer displayed.



- The point number that was read in is displayed until the current JOB is changed.
- When [**SRCH**] is pressed, SET searches data in the current JOB first, then in the Coordinate Search JOB.
- If more than two points with the same point name exist in the current JOB, SET finds the newer data only.

12.2 Setting Azimuth Angle from Backsight Coordinates

Set the azimuth angle of the backsight station by calculating by the coordinates.

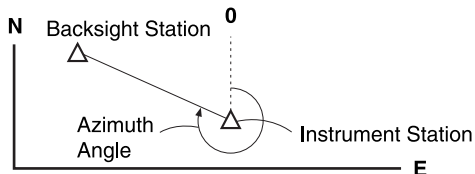

► PROCEDURE

1. Enter the instrument station data.

☞ "12.1 Entering Instrument Station Data and Azimuth Angle " steps 1 to 3

2. Press **[COORD]** to proceed to backsight coordinate input.

NO :	0.000
E0 :	0.000
Z0 :	0.000
Pt.	██████████
Inst. h	0.000m
READ	ANGLE COORD

3. Input the backsight station coordinates and press **[OK]**.
Angle measurement values are displayed in real time. Calculated Azimuth angle is also displayed.

Backsight	
NBS :	██████████ 1.000
EBS :	1.000
ZBS :	<Null>
READ	OK

- Press **[DIST]** to perform a horizontal distance check.

Backsight	
Take BS	
ZA	90°12'34"
HAR	123°12'34"
Azmth	45°00'00"
REC	DIST NO YES

- Press **[HT]** to set instrument and target height.
- Press **[REC]** to store check data in the current JOB

BS Hdist check	
calc H	0.000m
obs H	0.000m
dH	0.000m
REC	HT OK

- When you wish to read in the registered coordinate data, press **[READ]**.

☞ "12.1 Entering Instrument Station Data and Azimuth Angle PROCEDURE Reading in Registered Coordinate Data"

4. Press **[YES]** in the screen of step 3 to set azimuth angle. <Coord> is displayed again.

- When storing the azimuth angle in the current JOB, press **[REC]**.

☞ "23.2 Recording Backsight Point, PROCEDURE Inputting azimuth angle".

S	100.000m
ZA	90°00'00"
HAR	30°00'00"
Cd	████████████████████
Tgt.h	0.000m
OK	ADD LIST SRCH

12.3 3-D Coordinate Measurement

The coordinate values of the target can be found by measuring the target based on the settings of the instrument station and backsight station.

The coordinate values of the target are calculated using the following formulae.

$$N1 \text{ Coordinate} = N0 + S \times \sin Z \times \cos Az$$

$$E1 \text{ Coordinate} = E0 + S \times \sin Z \times \sin Az$$

$$Z1 \text{ Coordinate} = Z0 + S \times \cos Z + ih - fh$$

N0: Station point N coordinate S: Slope distance ih: Instrument height

E0: Station point E coordinate Z: Zenith angle fh: Target height

Z0: Station point Z coordinate Az: Direction angle



Z (zenith angle) is calculated as $360^\circ - Z$ when the telescope is in the face left position if either the horizontal angle has been set to 0 by pressing **[0SET]** or the required horizontal angle has been set by pressing **[H.ANG]**.

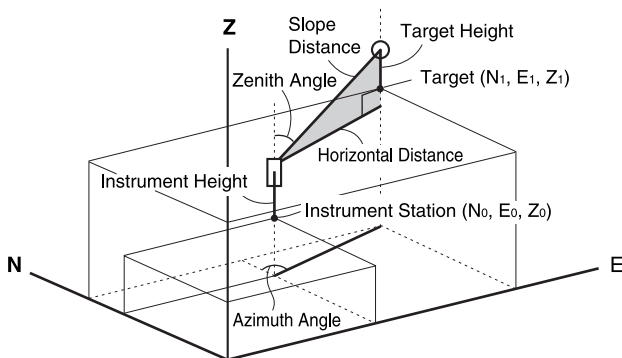

- If not measured or the space is left blank "Null" will be displayed.
If station point Z coordinate is set to "Null" the observation result for the Z coordinate is automatically set to "Null".

► PROCEDURE

1. Sight the target at the target point.

2. In <Coord>, select "Observation" to start measurement. The coordinate value of the target is displayed. Press **[STOP]** to quit measurement.

```
Coord.
  Stn. Orientation
  Observation
  EDM
```

- By pressing **[HT]**, the instrument station data can be reset. When the target height of the next target is different, reenter the target height before beginning the observation.
- **[REC]**: records measurement results
- **[AUTO]**: starts measurement and automatically records results after **[STOP]** has been pressed.

 Recording method:
"23. RECORDING DATA -
RECORD MENU -"

```
N          240.490
E          340.550
Z          305.740
ZA      89° 42' 50"
HAR     180° 31' 20"
AUTO OBS HT REC
```

3. Sight the next target and press **[OBS]** or **[AUTO]** to begin measurement. Continue until all targets have been measured.
- When coordinate measurement is completed, press **{ESC}** to return to <Coord>.

12.4 Coordinate Measurement and Outputting the Data

The following explains coordinate measurement and the features used to output measurement data to a computer or peripheral equipment.

 Communication cables: "35. OPTIONAL ACCESSORIES"

Output format and command operations: "Interfacing with the SOKKIA SDR Electronic Field Book" and "Command Explanations" manuals

► PROCEDURE

1. Connect SET and host computer.
2. Allocate the **[D-OUT]** softkey to the Meas mode screen.
 "28.3 Allocating Key Functions"
3. Sight the target point.
4. Press **[D-OUT]**, and select "Coord data" to output measurement data.
5. Press **[STOP]** to stop outputting data and return to Meas Mode

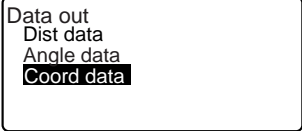

Data out
Dist data
Angle data
Coord data

13. RESECTION MEASUREMENT

Resection is used to determine the coordinates of an instrument station by performing multiple measurements of points whose coordinate values are known. Registered coordinate data can be recalled and set as known point data. Residual of each point can be checked, if necessary.

Entry

Coordinates of known point : (X_i, Y_i, Z_i)

Observed horizontal angle : H_i

Observed vertical angle : V_i

Observed distance : D_i

Output

Station point coordinates : (X_0, Y_0, Z_0)

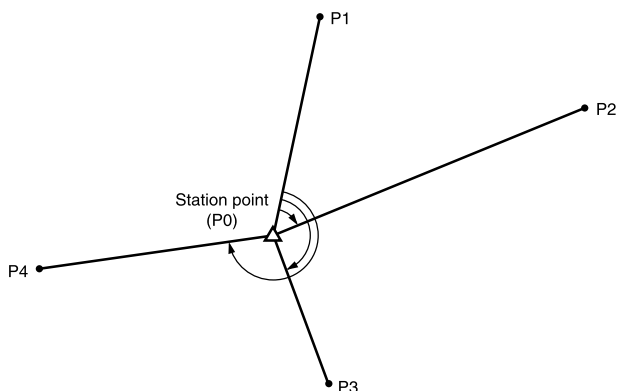

- All the N, E, Z or only Z data of an instrument station is calculated by measuring the known points.
- Coordinate resection measurement overwrites the N, E and Z data of the instrument station, but height resection does not overwrite N and E. Always perform resection measurement in the sequence described in "13.1 Coordinate Resection Measurement" and "13.2 Height Resection Measurement".
- Input known coordinate data and calculated instrument station data can be recorded in the current JOB.

 "24. SELECTING/DELETING A JOB"

13. RESECTION MEASUREMENT

13.1 Coordinate Resection Measurement

N, E, Z of an instrument station is determined by the measurement.

- Between 2 and 10 known points can be measured by distance measurement, and between 3 and 10 known points by angle measurement.

►PROCEDURE

1. In the second page of Meas mode screen, press **[MENU]**, then select "Resection".

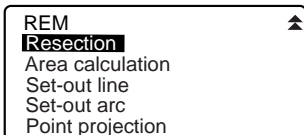

REM
Resection
Area calculation
Set-out line
Set-out arc
Point projection

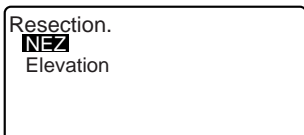

2. Select "NEZ".

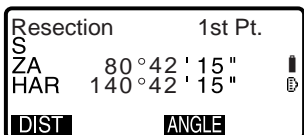

Resection.
NEZ
Elevation

3. Sight the first known point and press **[DIST]** to begin measurement.
The measurement results are displayed on the screen.



Resection 1st Pt.
S
ZA 80°42'15" 
HAR 140°42'15" 
[DIST] **[ANGLE]**

- When **[ANGLE]** has been selected, the distance cannot be displayed.

4. Press **[YES]** to use the measurement results of the first known point.

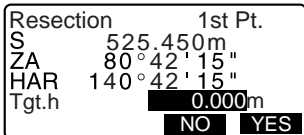

Resection 1st Pt.
S 525.450m
ZA 80°42'15"
HAR 140°42'15"
Tgt.h **0.000m**
 [NO] **[YES]**

- You can also input target height here.

5. Input coordinates for the first known point and press **[NEXT]** to move to the second point.

- When **[READ]** is pressed, registered coordinates can be recalled and used.

 "12.1 Entering Instrument Station Data and Azimuth Angle PROCEDURE Reading in Registered Coordinate Data"

- Press **[ESC]** to return to the previous known point.

1st Pt.	
Np :	20.000
Ep :	30.000
Zp :	40.000
Tgt . h :	10.000m
READ	REC NEXT

6. Repeat procedures 3 to 5 in the same way from the second point. When the minimum quantity of observation data required for the calculation is present, **[CALC]** is displayed.

7. Press **[CALC]** to automatically start calculations after observations of all known points are completed. Instrument station coordinate and standard deviation, which describes the measurement accuracy, are displayed.

3rd Pt.	
Np :	20.000
Ep :	30.000
Zp :	40.000
Tgt . h :	10.000m
READ	REC NEXT CALC

8. Press **[RESULT]** to check the result.
If there are no problems with the result, press **[ESC]** and go to step 10.

N	100.001
E	100.000
Z	9.999
σ N	0.0014m
σ E	0.0007m
RESULT	REC OK

- **[REC]**: records measurement results

 Recording method:
"23. RECORDING DATA - RECORD MENU -"

		σ N	σ E
1st	-0.001	0.001	
* 2nd	0.005	0.010	
3rd	-0.001	0.001	
4th	-0.003	-0.002	▼
BAD	RE CALC	RE OBS	ADD

13. RESECTION MEASUREMENT

- Press **[ADD]** when there is a known point that has not been measured or when a new known point is added.
9. If there are problems with the results of a point, align the cursor with that point and press **[BAD]**. “*” is displayed on the left of the point. Repeat for all results that include problems.
10. Press **[RE CALC]** to perform calculation again without the point designated in step 9. The result is displayed.
If there are no problems with the result, go to step 11.
If problems with the result occur again, perform the resection measurement from step 3.
- Press **[RE OBS]** to measure the point designated in step 9.
If no points are designated in step 9, all the points or only the final point can be observed again.
11. Press **[OK]** in the screen of step 8 to finish resection measurement. The instrument station coordinate is set.
Press **[YES]** when you want to set the azimuth angle of the first known point as the backsight point.
- Press **[NO]** to return to Meas Mode without setting the azimuth angle.



Resection
Start point
Last point



- It is also possible to perform resection measurement by pressing **[RESEC]** when allocated to the Meas mode screen.
 Allocating **[RESEC]**: "28.3 Allocating Key Functions"
- Even if "inch" is selected in Config mode, standard deviation is displayed in "feet" or "US feet" depending on the feet unit selected.

13.2 Height Resection Measurement

Only Z (height) of an instrument station is determined by the measurement.

- Known points must be measured by distance measurement only.
- Between 1 and 10 known points can be measured.

► PROCEDURE

1. In the second page of Meas mode screen, press **[MENU]**, then select "Resection".

2. Select "Elevation".

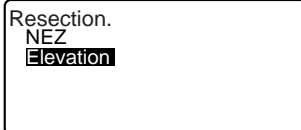

3. Sight the first known point and press **[OBS]** to begin measurement. Press **[STOP]**. The measurement results are displayed on the screen.

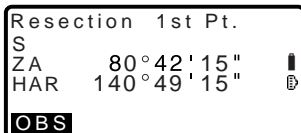

4. Press **[YES]** to use the measurement results of the first known point.

5. Input the known point. After setting the elevation for the first known point, press **[NEXT]** to move to the second point.

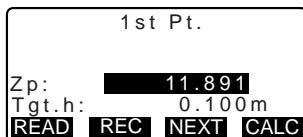

6. If measuring two or more known points, repeat procedures 3 to 4 in the same way from the second point.

- Press **{ESC}** to return to the previous known point.

7. Press **[CALC]** to automatically start calculations after observations of all known points are completed. Instrument station elevation and standard deviation, which describes the measurement accuracy, are displayed.

8. Press **[RESULT]** to check the result.
If there are no problems in the result, press **{ESC}** and go to step 11.

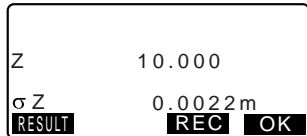

9. If there are problems with the results of a point, align the cursor with that point and press **[BAD]**. “*” is displayed on the left of the point.

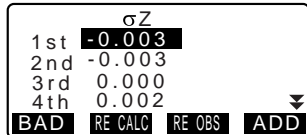

10. Press **[RE CALC]** to perform calculation again without the point designated in step 9. The result is displayed.

If there are no problems with the result, go to step 11.

If problems with the result occur again, perform the resection measurement from step 3.

11. Press **[OK]** to finish resection measurement. Only Z (elevation) of the instrument station coordinate is set. N and E values are not overwritten.

13. RESECTION MEASUREMENT



Resection calculation process

The NE coordinates are found using angle and distance observation equations, and the instrument station coordinates are found using the method of least squares. The Z coordinate is found by treating the average value as the instrument station coordinates.

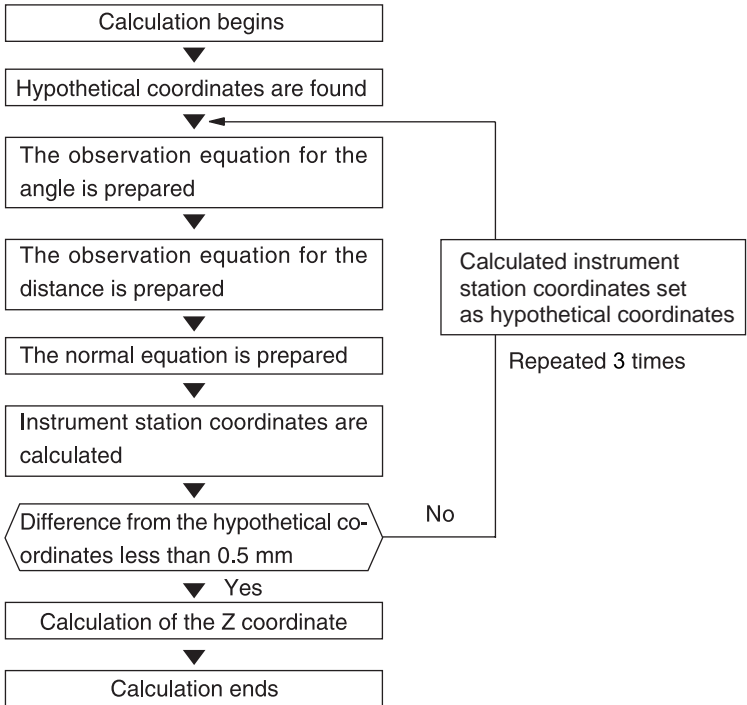



Precaution when performing resection

In some cases it is impossible to calculate the coordinates of an unknown point (instrument station) if the unknown point and three or more known points are arranged on the edge of a single circle.

An arrangement such as that shown below is desirable.



It is sometimes impossible to perform a correct calculation in a case such as the one below.

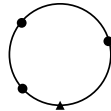

When they are on the edge of a single circle, take one of the following measures.

- (1) Move the instrument station as close as possible to the center of the triangle.
- (2) Observe one more known point which is not on the circle
- (3) Perform a distance measurement on at least one of the three points.

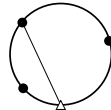
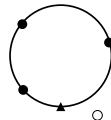
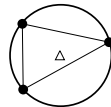

- In some cases it is impossible to calculate the coordinates of the instrument station if the included angle between the known points is too small. It is difficult to imagine that the longer the distance between the instrument station and the known points, the narrower the included angle between the known points. Be careful because the points can easily be aligned on the edge of a single circle.

14. SETTING-OUT MEASUREMENT

Setting-out measurement is used to set out the required point.

The difference between the previously input data to the instrument (the setting-out data) and the measured value can be displayed by measuring the horizontal angle, distance or coordinates of the sighted point.

The horizontal angle difference and distance difference are calculated and displayed using the following formulae.

Horizontal angle difference

dHA = Horizontal angle of setting-out data - measured horizontal angle

Distance difference

Distance Displayed item

Sdist: S-O S =measured slope distance - slope distance of setting-out data

Hdist: S-O H =measured horizontal distance - horizontal distance of setting-out data

Vdist: S-O V =measured height difference - height difference of setting-out data

- Setting out data can be input in various modes: coordinates, horizontal distance, slope distance, height difference and REM measurement.
- In slope distance, horizontal distance, height difference, and coordinate mode, registered coordinates can be recalled and used as setting-out coordinates. In slope distance, horizontal distance and height difference, S/H/V distances are calculated from the read in setting-out coordinate, instrument station data, instrument height, and target height.
- Setting-out measurement can be carried out effectively using the Guide light.  "4.1 Parts of the Instrument", "5.1 Basic Key Operation" and "35. OPTIONAL ACCESSORIES"
- EDM settings can be set in the Setting-out measurement menu.
- If not measured or the space is left blank "Null" will be displayed. If distance or angle of setting-out data is set to "Null" the Distance difference is automatically set to "Null"

14.1 Coordinates Setting-out Measurement

After setting the coordinates for the point to be set out, the SET calculates the setting-out horizontal angle and horizontal distance. By selecting the horizontal angle and then the horizontal distance setting-out functions, the required coordinate location can be set out.

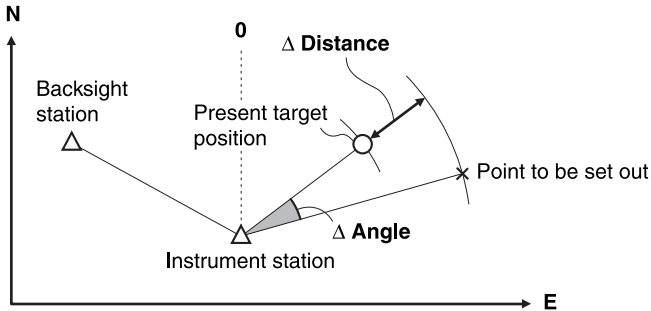

- To find the Z coordinate, attach the target to a pole etc. with the same target height.

► PROCEDURE

1. Press **[S-O]** on the third page of the Meas mode screen to display <S-O>.
2. Enter the instrument station data.
 "12.1 Entering Instrument Station Data and Azimuth Angle PROCEDURE Reading in Registered Coordinate Data"
3. Set the azimuth angle of the backsight point.
 "12.2 Setting Azimuth Angle from Backsight Coordinates" steps 2 to 6

14. SETTING-OUT MEASUREMENT

4. Select "S-O data". <S-O Coord> is displayed.

```
S-O
Stn. Orientation
S-O data
Observation
EDM
```

5. Enter the coordinates of the setting-out point.

- When **[READ]** is pressed, registered coordinates can be recalled and used as setting-out coordinates.

 "12.1 Entering Instrument Station Data and Azimuth Angle PROCEDURE Reading in Registered Coordinate Data"

- When **[▲S-O]** is pressed, input coordinates are calculated and displayed in "H dist" and "H ang".

```
S-O Coord
Np: 100.000
Ep: 100.000
Zp: 50.000
Tgt. h: 1.400m
READ ▲S-O OK
```

6. Press **[OK]** to set the setting-out data.

```
S-O H
H dist: 3.300m
H ang: 40.0000
P1
READ ▲S-O OK
```

7. Rotate the top of the instrument until "dHA" is 0° and place the target on the sight line.

8. Press **[OBS]** to begin setting-out measurement.
The target and the distance of the point to be set out is displayed (S-OΔH).

```
S-OΔH 0.820m
dHA 0°09'40"
H 2.480m
ZA 75°20'30"
HAR 39°05'20"
OBS ▲S-O ← → REC
```

```
S-OΔH 0.820m
dHA 0°09'40"
H 2.480m
ZA 75°20'30"
HAR 39°05'20"
—* STOP
```

9. Move the prism forward and backward until the setting-out distance is 0m. If S-OΔH is "+", move the prism toward yourself, if it is "-", move the prism away from yourself.

- By pressing [← →], an arrow pointing to the left or right displays which direction the target should be moved.

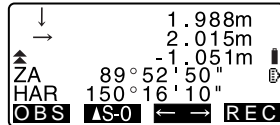

- ← : Move the prism to left.
- : Move the prism to right.
- ↓ : Move the prism forward.
- ↑ : Move the prism away.
- ▲ : Move the prism upward.
- ▼ : Move the prism downward.

When the target is within measurement range, all four arrows are displayed.

10. Press {ESC} to return to <S-O>.

- When [READ] was used in step 5, the list of registered coordinates is restored. Continue setting-out measurement.
- [REC]: records measurement results

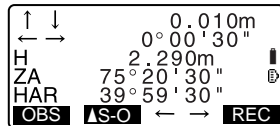

11.  Recording method:
"23. RECORDING DATA -
RECORD MENU -"

14. SETTING-OUT MEASUREMENT

14.2 Distance Setting-out Measurement

The point to be found based on the horizontal angle from the reference direction and the distance from the instrument station.

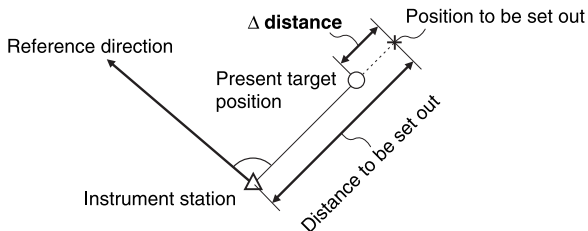

► PROCEDURE

1. Press **[S-O]** in the third page of the Meas mode screen to display <S-O>.
2. Enter the instrument station data.
☞ "12.1 Entering Instrument Station Data and Azimuth Angle PROCEDURE Reading in Registered Coordinate Data".
3. Set the azimuth angle of the backsight point.
☞ "12.2 Setting Azimuth Angle from Backsight Coordinates" steps 2 to 6
4. Select "S-O data."
5. Press **[▲S-O]** until <S-O H> is displayed.

S-O	Coord	
Np:	100.000	
Ep:	100.000	
Zp:	50.000	
Tgt. h:	1.400m P1	
READ	▲S-O	OK

6. Press [**▲S-O**] to select distance input mode.
 Each time [**▲S-O**] is pressed: S-O Coord (coordinates), S-O H (horizontal distance), S-O S (slope distance), S-O V (height difference), S-O Ht. (REM measurement).

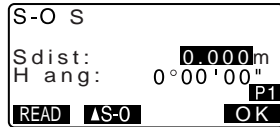

☞ "14.1 Coordinates Setting-out Measurement", "14.3 REM Setting-out Measurement"

- When [**READ**] is pressed, registered coordinates can be recalled and used. Distance and angle are calculated using the coordinate value.

☞ "12.1 Entering Instrument Station Data and Azimuth Angle PROCEDURE Reading in Registered Coordinate Data"

7. Set the following items.
- (1) Sdist/Hdist/Vdist: distance from the instrument station to the position to be set out.
 - (2) H ang: included angle between the direction of the reference and the point to be set out.

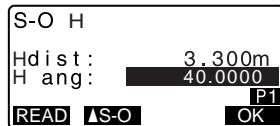

- Pressing [**COORD**] in the second page allows you to enter the coordinates of the point to be set out.

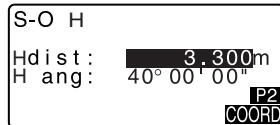

8. Press [**OK**] to set the input values.
9. Rotate the top of the instrument until "dHA" is 0° and place the target on the sight line.

14. SETTING-OUT MEASUREMENT

10. Press **[OBS]** to start distance measurement. The target and the distance of the point to be set out is displayed (S-O Δ H).

S-O Δ H	0.820m	
dHA	0° 09' 40"	
H	2.480m	
ZA	75° 20' 30"	
HAR	39° 05' 20"	
OBS	S-O	← →
		REC

11. Move the prism to find the point to be set out.
12. Press **{ESC}** to return to <S-O>.

- When **[READ]** was used in step 5, the list of registered coordinates is restored. Continue setting-out measurement.
 - **[REC]**: records measurement results
-  Recording method:
"23. RECORDING DATA -
RECORD MENU -"

14.3 REM Setting-out Measurement

To find a point where a target cannot be directly installed, perform REM setting-out measurement.

 "11.5 REM Measurement"

►PROCEDURE

1. Install a target directly below or directly above the point to be found, then use a measuring tape etc. to measure the target height (height from the survey point to the target).
2. Press **[S-O]** in the Meas mode screen to display <S-O>.

3. Enter the instrument station data.

 "12.1 Entering Instrument Station Data and Azimuth Angle PROCEDURE Reading in Registered Coordinate Data".

4. Select "S-O data" and press [**▲S-O**] until <S-O Ht.> is displayed.

5. Input height from the surveying point to the position to be set out in "SO dist".

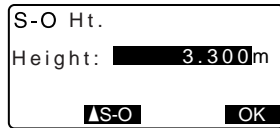



6. After inputting the data, press [**OK**].

7. Press [**REM**] to begin REM setting-out measurement. Move the telescope to find the point to be set out.

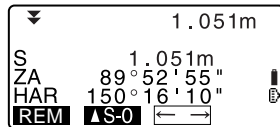
 "14.2 Distance Setting-out Measurement" steps 9 to 10



 : Move the telescope near the zenith.

 : Move the telescope near the nadir.

8. When the measurement is completed, press [**ESC**] to restore <S-O>.

15. SETTING-OUT LINE

Setting-out line is used for setting out a required point at a designated distance from the baseline and for finding the distance from the baseline to a measured point.

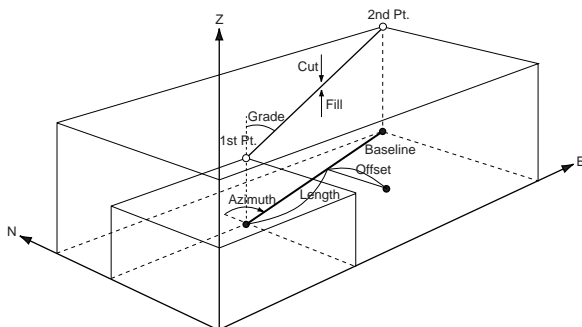

15.1 Defining Baseline

To perform setting-out line measurement, first, define the baseline. The baseline can be defined by inputting the coordinates of, or by observing the two points. The scale factor value is the difference between the input coordinates and the observed coordinates.

$$\text{Scale (X, Y)} = \frac{\text{Hdist}' \text{ (horizontal distance calculated from the measured value)}}{\text{Hdist} \text{ (horizontal distance calculated from the input coordinates)}}$$

- When not observing first or second points, scale factor is set to "1".
- Defined baseline can be used in both setting-out line measurement and point projection.

► PROCEDURE Defining by inputting coordinates

1. In the second page of Meas mode screen, press [MENU], then select "Set-out line".

```
REM
Resection
Area calculation
Set-out line
Set-out arc
Point projection
```

2. Enter the instrument station data.

☞ "12.1 Entering Instrument Station Data and Azimuth Angle PROCEDURE Reading in Registered Coordinate Data"

3. Select "Define baseline" in <Set-out line>.

```
Set-out line
Stn. Orientation
Define baseline
Set-out line
```

4. Enter the first point data and press [OK].

- When [READ] is pressed, registered coordinates can be recalled and used.

☞ "12.1 Entering Instrument Station Data and Azimuth Angle PROCEDURE Reading in Registered Coordinate Data"

```
Define 1st Pt.
Np: 113.464
Ep: 91.088
Zp: 12.122
READ REC OBS OK
```

5. Enter the second point data.

```
Define 2nd Pt.
Np: 112.706
Ep: 104.069
Zp: 11.775
READ REC OBS OK P1
```

6. Press {FUNC}.
[MEAS] is displayed.

- When not observing the first point and the second point, go to step 12.

```
Define 2nd Pt.
Np: 112.706
Ep: 104.069
Zp: 11.775
P2
MEAS
```

7. Press [MEAS] on the screen of step 6 to move to observation of the first point.

15. SETTING-OUT LINE

8. Sight the first point and press **[OBS]**.

The measurement results are displayed on the screen.

```
Measure 1st Pt.
Np:      113.464
Ep:      91.088
Zp:      12.122
[OBS]
```

- Press **[STOP]** to stop the measurement.
- You can input target height here.

9. Press **[YES]** to use the measurement results of the first point.

```
Measure      1st Pt.
S           525.450m
ZA          80°30'15"
HAR        120°10'00"
Tgt.h      1.400m
[NO] [YES]
```

- Press **[NO]** to observe the first point again.

10. Sight the second point and press **[OBS]**.

11. Press **[YES]** to use the measurement results of the second point.

The distance between the two measured points, the distance calculated from inputting the coordinates of two points and the scale factors are displayed.

```
Azimuth 93 20'31"
Hcalc   13.003m
Hmeas
ScaleX  1.000091
ScaleY  1.000091
[Sy=1] [Sy=Sx] [OK]
```

```
Grade  %-2.669
[1:**] [%] [OK]
```

12. Press **[OK]** on the screen of step 11 to define the baseline. <Set-out line> is displayed. Move to setting-line measurement.

 "15.2 Setting-out Line Point"/
"15.3 Setting-out Line Line"

```
Set-out line
[Point]
Line
```

- Press **[Sy=1]** to set scale factor y to "1".
- Press **[1 : **]** to change the grade display mode to "1 : ** = elevation : horizontal distance".



- It is also possible to perform setting-out line measurement by pressing [**S-O LINE**] when allocated to the Meas mode screen.
 Allocating [**S-O LINE**]: "28.3 Allocating Key Functions".

►PROCEDURE Defining by observation

- In the second page of Meas mode screen, press [**MENU**], then select "Set-out line".
- Enter the instrument station data.
 "12.1 Entering Instrument Station Data and Azimuth Angle PROCEDURE Reading in Registered Coordinate Data"

- Select "Define baseline" in <Set-out line>.

- Sight the first point and press [**OBS**].

- Press [**STOP**] to stop the measurement.

Define 1st Pt.	
Np:	0.000
Ep:	0.000
Zp:	0.000
<div style="display: flex; justify-content: space-between; width: 100%;"> READ REC OBS OK </div>	

- Press [**OK**] to use the measurement results of the first point.

- Press [**OBS**] to observe the first point again.
- Press [**HT**] to input instrument and target height.

Np:	113.464
Ep:	91.088
Zp:	12.122
ZA	90°00'00"
HAR	120°10'00"
<div style="display: flex; justify-content: space-between; width: 100%;"> HT REC OBS OK </div>	

- Sight the second point and press [**OBS**].

Define 2nd Pt.	
Np:	0.000
Ep:	0.000
Zp:	0.000
<div style="display: flex; justify-content: space-between; width: 100%;"> READ REC OBS OK </div>	

15. SETTING-OUT LINE

7. Press **[OK]** to use the measurement results of the second point.

- Press **[OBS]** to observe the second point again.
- Press **[HT]** to input instrument and target height.
- Scale factor settings can be set in the screen shown at right.

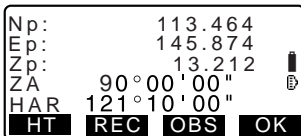

Np: 113.464
Ep: 145.874
Zp: 13.212
ZA 90°00'00"
HAR 121°10'00"
HT REC OBS OK

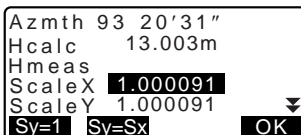

Azmth 93 20'31"
Hcalc 13.003m
Hmeas
ScaleX 1.000091
ScaleY 1.000091
Sy=1 Sv=Sx OK

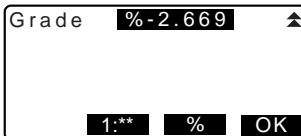

Grade % -2.669
1:** % OK

8. Press **[OK]** on the third screen of step 7 to define the baseline. <Set-out line> is displayed. Move to setting-line measurement.
 "15.2 Setting-out Line Point"/
"15.3 Setting-out Line Line"

- Press **[Sy=1]** to set scale factor y to "1".
- Press **[1 : **]** to change the grade display mode to "1 : ** = elevation : horizontal distance".

Note

• It is also possible to perform setting-out line measurement by pressing **[S-O LINE]** when allocated to the Meas mode screen.

 Allocating **[S-O LINE]**: "28.3 Allocating Key Functions".

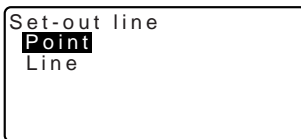

Set-out line
Point
Line

15.2 Setting-out Line Point

Setting-out line point measurement can be used to find the required point coordinate by inputting the length and offset based on the baseline.

- Before performing setting-out line point, the baseline must be defined.

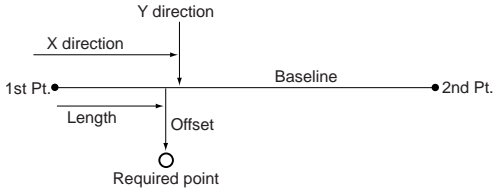

► PROCEDURE

1. Select "Point" in <Set-out line>
2. Set the following items.
 - (1) Incr: Increment by which line length and offset can be increased/decreased using the arrow softkeys.
 - (2) Line: Distance along the baseline from the first point to the position at which a line extending from the required point intersects the baseline at right angles (X direction).
 - (3) Offset: Distance from the required point to the position at which a line extending from the required point intersects the baseline at right angles (Y direction).
 - [←]/[→]: Press to decrease/increase the value by the amount set in "Incr".

Set-out line
Point
Line

Set-out line
Incr 1.000m
Line 0.000m
Offset 0.000m
OFFSET [←] [→] OK

15. SETTING-OUT LINE

3. Press **[OK]** on the screen of step 2. The coordinate value of the required point is calculated and displayed.

Set-out line	
N	111.796
E	94.675
Z	12.024
REC ▲S-O	

- **[REC]**: records the coordinate value as a known point data.

 Recording method:

"25.1 Registering/Deleting
Known Point Data"

- Press **▲ S-O** to move to setting-out measurement of the required point.

 "14. SETTING-OUT
MEASUREMENT"

4. Press **{ESC}**. Continue the measurement (repeat steps from 2).

► PROCEDURE Offsetting the baseline

The baseline can be offset in three dimensions using four methods: lengthwise offset, lateral offset, height offset, and rotation angle offset.

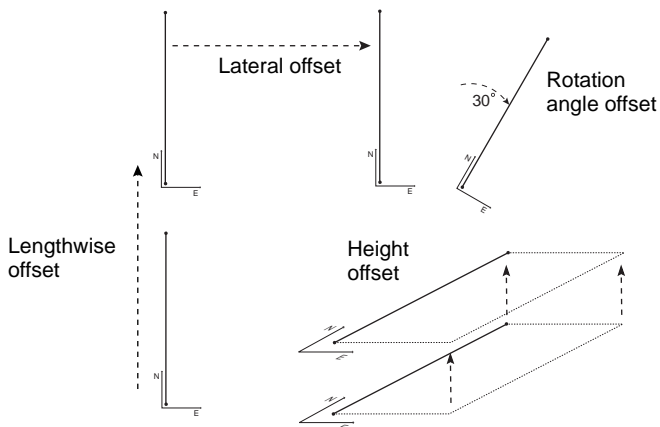

1. Select "Point" in <Set-out line>

Set-out line
Point
 Line

2. Press **[OFFSET]** to display <Baseline offset>.

Set-out line
 Incr 1.000m
 Line **0.000m**
 Offset 0.000m

OFFSET ← → **OK**

15. SETTING-OUT LINE

3. Set the following items.
 - (1) Incr: Increment by which offsets can be increased/ decreased using the arrow softkeys.
 - (2) Length: Lengthwise offset
 - (3) Lateral: Lateral offset
 - (4) Height: Elevation offset
 - (5) Rt.ang: Rotation angle offset
- [**←**]/[**→**]: Press to increase/ decrease the value by the amount set in "Incr".
4. Press [**OK**] to return to the screen in step 2.
 - [**MOVE**]: Permanently moves the baseline coordinates by the amount set in <Baseline offset>.
5. Press [**OK**] on the screen of step 2. The coordinate value of the required point is calculated, taking into account the movement of the baseline, and displayed.

Baseline offset	
Incr	1.000m
Length	0.000m
Lateral	0.000m
Height	0.000m ▾
MOVE	← → OK

Rt.ang	0.0000 ▲
MOVE	OK

Set-out line	
N	185.675
E	102.482
Z	9.662
REC	▲S-O

15.3 Setting-out Line Line

Setting-out line line measurement tells how far horizontally the measured point is from the baseline and how far vertically the measured point is from the connected line. The baseline can be offset in a horizontal direction if necessary.

- Before performing setting-out line line, the baseline must be defined.

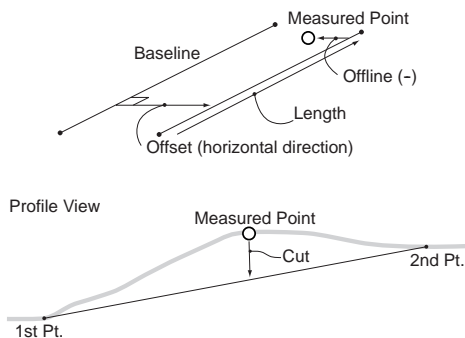

► PROCEDURE

1. Select "Line" in <Set-out line>.

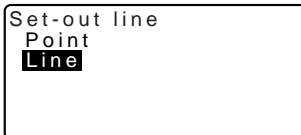

2. Enter the offset value.

- Offset: How much to move the baseline.
A positive value indicates right side and a negative value indicates left side.
- When not setting offset value, go to step 3.

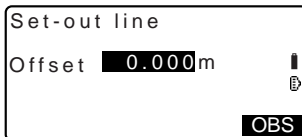

15. SETTING-OUT LINE

3. Sight the target and press **[OBS]** on the screen of step 2.

The measurement results are displayed on the screen.

Press **[STOP]** to stop the measurement.

4. Press **[YES]** to use the measurement results.
Displays the difference between the measured point and the baseline.

Set-out line	
S	525.450m
ZA	80°30'15"
HAR	120°10'00"
Tgt.h	1.400m
	NO YES

- Offline: A positive value indicates the point is on the right of the baseline and a negative value indicates it is on the left.
- "Cut" indicates that the point is below the baseline.
- "Fill" indicates that the point is above the baseline.
- Length: Distance along the baseline from the first point to the measured point.
- Press **[NO]** to observe the target again.

5. Sight the next target and press **[OBS]** to continue the measurement.

Set-out line	
Offline	-0.004m
Cut	0.006m
Length	12.917m
	REC OBS

- Press **[REC]**: records measurement results.

 Recording method:
"23. RECORDING DATA -
RECORD MENU -"

16. SETTING-OUT ARC

This mode allows the operator to define an arc from various arc parameters, such as From Pt. coordinates, and set out this arc as well as points (offsets) along it.

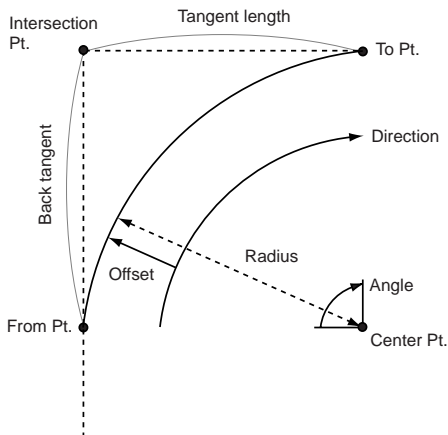

16.1 Defining an Arc

An arc can be defined by inputting arc parameters such as arc radius, angle, coordinates for the From point, Center point, To point etc. An arc can also be defined by observation of the From point, Center point, To point etc.

► PROCEDURE Defining by inputting coordinates

1. In the second page of the Meas mode screen, press [MENU], then select "Set-out arc".

```
REM
Resection
Area calculation
Set-out line
Set-out arc
Point projection
```

2. Enter the instrument station data.
☞ "12.1 Entering Instrument Station Data and Azimuth Angle PROCEDURE Reading in Registered Coordinate Data"

16. SETTING-OUT ARC

3. Select "Define arc" in <Set-out arc>.

- When **[READ]** is pressed, registered coordinates can be recalled and used.

 "12.1 Entering Instrument Station Data and Azimuth Angle PROCEDURE Reading in Registered Coordinate Data"

```
Set-out arc
Stn.Orientation
Define arc
Set-out arc
```

```
From Pt.
Np: 0.000
Ep: 0.000
Zp: 0.000
READ REC OBS OK
```

4. Enter the arc From point data and press **[OK]**.

5. Press **[F1]**/**[F2]** to select coordinates then press **[OK]**.

To : Enter arc To point.

To/Center : Enter arc To point and Center point.

To/Intersect : Enter arc To point and Intersect point (intersection of the tangents).

Center : Enter arc Center point.

Intersect : Enter arc Intersect point.

Center/Intersect: Enter arc Center point and Intersect point (intersection of the tangents).

```
Select Pt.
To
OK
```

6. Enter the coordinates specified in step 5.

7. Press **[OK]** to proceed to arc parameter input.

```
To Pt.
Np: 0.000
Ep: 0.000
Zp: 0.000
READ REC OBS OK
```

- When entering multiple coordinates, **[NEXT]** is displayed instead of **[OK]**. Press **[NEXT]** to input data for the next point.

8. Enter other arc parameters.

- Direction (whether the arc turns right/left from the From point)
- Radius (radius of the arc)
- Angle (subtended angle)
- Arc (distance along the arc)
- Chord (straight line distance between the From and To points)
- Tan In (tangent length)
- Bk tan (back tangent length)

Direction:	Left
Radius:	<Null>
Angle :	<Null>
Arc :	<Null>
Chord :	141.421m
OK	

Tan In:	<Null>
Bk tan:	<Null>
OK	



Parameters that can be entered may be restricted depending on the coordinates specified in step 5.



"Specifying coordinates and curve parameters"

9. Enter curve parameters then press **[←]**. Other parameters will be calculated.

- [TO]**: Calculated coordinates for To point can be recorded.
- [CENTER]**: Calculated coordinates for Center point can be recorded.
- [INTSCT]**: Calculated coordinates for Intersect point can be recorded.

Direction:	Right
Radius:	100.000m
Angle :	90°00'00"
Arc :	157.080m
Chord :	141.421m
INTSCT	OK

10. Press **[OK]** on the screen of step 9 to define the arc. <Set-out arc> is displayed. Move to setting-out arc measurement.

16. SETTING-OUT ARC

 "16.2 Setting-out Arc" step 2



- It is also possible to perform setting-out arc measurement by pressing [**S-O ARC**] when allocated to the Meas mode screen.

 Allocating [**S-O ARC**]: "28.3 Allocating Key Functions"

► PROCEDURE Defining by observation

- In the second page of Meas mode screen, press [**MENU**], then select "Set-out arc".

- Enter the instrument station data.

 "12.1 Entering Instrument Station Data and Azimuth Angle PROCEDURE Reading in Registered Coordinate Data"

- Select "Define arc" in <Set-out arc>.

- Sight the From point and press [**OBS**].



- Press [**STOP**] to stop the measurement.

From Pt.	
Np:	0.000
Ep:	0.000
Zp:	0.000
[READ] [REC] [OBS] [OK]	

- Press [**OK**] to use the measurement results of the From point.

- Press [**OBS**] to observe the first point again.
- Press [**HT**] to input instrument and target height.

Np:	113.464
Ep:	91.088
Zp:	12.122
ZA	90°00'00"
HAR	120°10'00"
[HT] [REC] [OBS] [OK]	

- Press / to select coordinates then press [**OK**].

Select Pt.
To
[OK]

7. Sight the To/Center/Intersect point and press **[OBS]**.

To Pt.	
Np :	0.000
Ep :	0.000
Zp :	0.000
READ	REC OBS OK

8. Press **[OK]** to use the measurement results of the To/Center/Intersect point.

Np :	113.464
Ep :	91.088
Zp :	12.122
ZA	90°00'00"
HAR	120°10'00"
HT	REC OBS OK

- Press **[OBS]** to observe the second point again.
- Press **[HT]** to input instrument and target height.
- When entering multiple points, **[NEXT]** is displayed instead of **[OK]**. Press **[NEXT]** to observe the next point.

9. Enter other arc parameters.

- (1) Direction (whether the arc turns right/left from the From point)
- (2) Radius (radius of the arc)
- (3) Angle (subtended angle)
- (4) Arc (distance along the arc)
- (5) Chord (straight line distance between the From and To points)
- (6) Tan In (tangent length)
- (7) Bk tan (back tangent length)

Direction:	Left
Radius:	<Null>
Angle :	<Null>
Arc :	<Null>
Chord :	141.421m
	OK

Tan In:	<Null>
Bk tan:	<Null>
	OK



Parameters that can be entered may be restricted depending on the coordinates specified in step 5.



" Specifying coordinates and curve parameters"

16. SETTING-OUT ARC

10. Enter curve parameters then press **[←]**. Other parameters will be calculated.

- **[TO]**: Observation data for To point can be recorded.

[CENTER]: Observation data for Center point can be recorded.

[INTSCT]: Observation data for Intersect point can be recorded.

Direction:	Right
Radius:	100.000m
Angle:	90°00'00"
Arc:	157.080m
Chord:	141.421m
[INTSCT]	[OK]

11. Press **[OK]** on the screen of step 10 to define the arc. <Set-out arc> is displayed. Move to setting-out arc measurement.

 "16.2 Setting-out Arc" step 2



- It is also possible to perform setting-out arc measurement by pressing **[S-O ARC]** when allocated to the Meas mode screen.

 Allocating **[S-O ARC]**: "28.3 Allocating Key Functions"



Specifying points and curve parameters

Parameters that can be entered may be restricted depending on the points specified in step 5/6. Parameters that can be entered are marked with a circle (○). Those that cannot are marked with a cross (×).

Parameters Set coord	Radius	Angle	Arc	Chord	Tan In	Bk tan	Directi on
To pt Center pt	×	×	×	×	×	×	○
To pt Intersect pt	×	×	×	×	×	×	○
Center pt Intersect pt	×	×	×	×	×	×	○
To pt	○	○	○	×	○	○	○
Center pt	×	○	○	○	○	×	○
Intersect pt	○	○	×	○	×	×	○



Precaution when performing setting-out arc

In the following cases parameters cannot be calculated:

when Radius < $\frac{\text{Chord}}{2}$

When Arc < Chord

When Tan In × 2 < Chord

When the included angle between the back tangent and the azimuth angle between the From Pt. and To Pt is 0°, or exceeds 180°.

16.2 Setting-out Arc

Setting-out arc measurement can be used to find the coordinates of required points along the arc by inputting the arc (or chord) length and offset based on the arc.

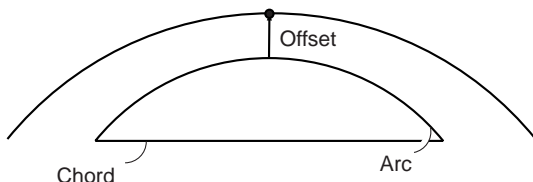

- Before performing setting-out arc, the arc must be defined.

► PROCEDURE

1. Select "Set-out arc" in <Set-out arc>.
2. Set the following items.
 - (1) Incr: Increment by which values can be increased/decreased using the arrow softkeys.
 - (2) Arc: Distance along the defined arc from the From point to the required point.
 - (2)' Chord: Distance along the chord of the defined arc from the From point to the required point.
 - (3) Offset: Distance from the required point to the position on a curve parallel to the original defined arc. A positive value indicates an offset arc to the right, and a negative value indicates an arc to the left.

```
Set-out arc
Stn.Orientation
Define arc
Set-out arc
```

```
Set-out arc
Incr : 1.000m
Arc : 20.000m
Offset: 5.000m
```

CHORD ← → OK P1

- Press **[CHORD]** to switch to Chord input.
- **[←]/[→]**: Press to decrease/increase the value by the amount set in "Incr".

Set-out arc	
Incr :	1.000m
Chord :	0.000m
Offset :	0.000m
P1	
ARC	← → OK

3. Press **[OK]** on the screen of step 2. The coordinate value of the required point is calculated and displayed.

Set-out arc	
N	118.874
E	106.894
Z	12.546
REC ▲S-O	

- **[REC]**: records the coordinate value as a known point data.
 Recording method:
 "25.1 Registering/Deleting Known Point Data"
- Press **▲S-O** to move to setting-out measurement of the required point.

 "14. SETTING-OUT MEASUREMENT"

4. Press **{ESC}**. Continue the measurement (repeat steps from 2).

16. SETTING-OUT ARC

► PROCEDURE Offsetting the arcline

The arcline can be offset in three dimensions using four methods: lateral offset, rotation angle offset, lengthwise offset, and height offset.

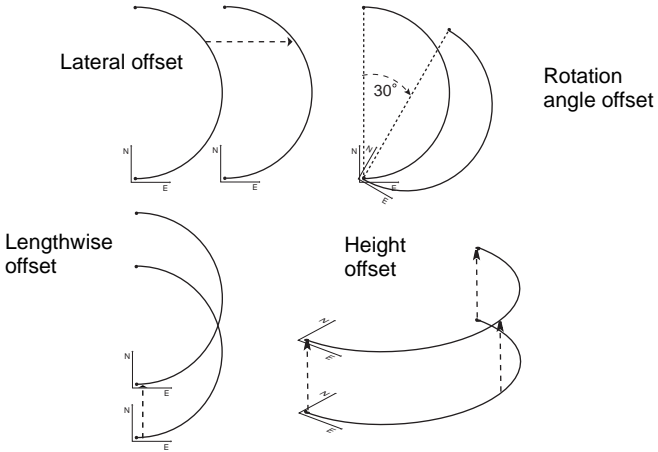

1. Select "Set-out arc" in <Set-out arc>.
2. Press **{FUNC}**, and then press **[OFFSET]** to display <Arcline offset>.

Set-out arc	
Incr :	1.000m
Arc :	20.000m
Offset :	5.000m
P2	
OFFSET	

3. Set the following items.
 - (1) Incr: Increment by which offsets can be increased/ decreased using the arrow softkeys.
 - (2) Length: Lengthwise offset
 - (3) Lateral: Lateral offset
 - (4) Height: Elevation offset
 - (5) Rt.ang: Rotation angle offset
 - **[←]/[→]**: Press to decrease/ increase the value by the amount set in "Incr".

Arcline offset	
Incr	1.000m
Length	0.000m
Lateral	0.000m
Height	0.000m
MOVE	← → OK

Rt.ang	0.0000
MOVE	OK

4. Press **[OK]** to return to the screen in step 2.
 - **[MOVE]**: Permanently moves the baseline coordinates by the amount set in <Arcline offset>.
5. Press **[OK]** on the screen of step 2. The coordinate value of the required point is calculated, taking into account the movement of the arcline, and displayed.

Set-out arc	
N	118.874
E	106.894
Z	12.546
REC ▲S-O	

17. POINT PROJECTION

Point projection is used for projecting a point onto the baseline. The point to project can be either measured or input. Displays the distances from the first point and point to project to the position at which a line extending from point to project intersects the baseline at right angles.

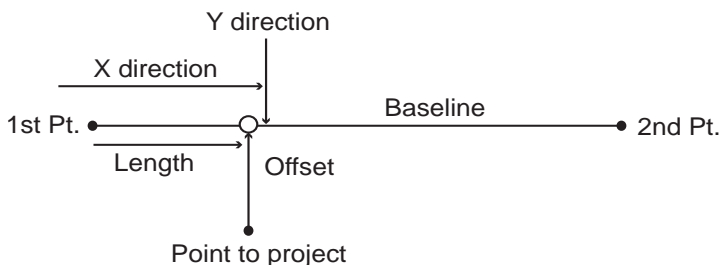

17.1 Defining Baseline

- Defined baseline can be used in both setting-out line measurement and point projection.

► PROCEDURE

1. In the second page of Meas mode screen, press **[MENU]**, then select "Point Projection".

```
REM
Resection
Area calculation
Set-out line
Set-out arc
Point projection
```

2. Enter the instrument station data then define the baseline.
☞ "15.1 Defining Baseline" step 2 to 13

3. Press **[OK]** to define the baseline. <Point projection> is displayed. Move to point projection measurement.
☞ "17.2 Point Projection"

```
Point projection
Np: 103.514
Ep: 101.423
Zp: 12.152
P1
READ OBS OK
```



- It is also possible to perform setting-out line measurement by pressing **[P-PROJ]** when allocated to the Meas mode screen.

Allocating the function key: "28.3 Allocating Key Functions"

17.2 Point Projection

Before performing point projection, the baseline must be defined.

► PROCEDURE

- Define the baseline.
 "17.1 Defining Baseline"
- Select "Point Projection" in <Point Projection>.

```
Point projection
Stn. Orientation
Define baseline
Point projection
```

- Enter the point coordinate.
 - Press **[OBS]** to observe the point to project.
 - When recording the data as a known point, press **{FUNC}**, and then press **[REC]** on the second page.

```
Point projection
Np: 103.514
Ep: 101.423
Zp: 12.152
P1
READ OBS OK
```

Recording method:
"25.1 Registering/Deleting
Known Point Data"

- Press **[OK]** on the screen of step 3.
The following items are calculated and displayed.

```
Point projection
Length 10.879m
Offset 9.340m
d.Elev 0.321m
XYZ REC AS-O
```

- Length: Distance along the baseline from the first point to the projected point (X direction).

17. POINT PROJECTION

- Offset: Distance from point to project to the position at which a line extending from point of project intersects the baseline at right angles. (Y direction).
- d.Elev: Elevation between the baseline and the projected point.
- Press **[XYZ]** to switch the screen display to coordinate values.
- Press **[OFFSET]** to switch the screen display to distance values.
- Press **[REC]**: records the coordinate value as a known point data.

 Recording method:
"25.1 Registering/Deleting
Known Point Data"

- Press **[▲ S-O]** to move to setting-out measurement of the projected point.

 "14. SETTING-OUT
MEASUREMENT"

5. Press **{ESC}**. Continue the measurement (repeat steps from 3).

18. INTERSECTIONS

It is possible to find an intersection point between 2 reference points by specifying the length or azimuth angle of either point.

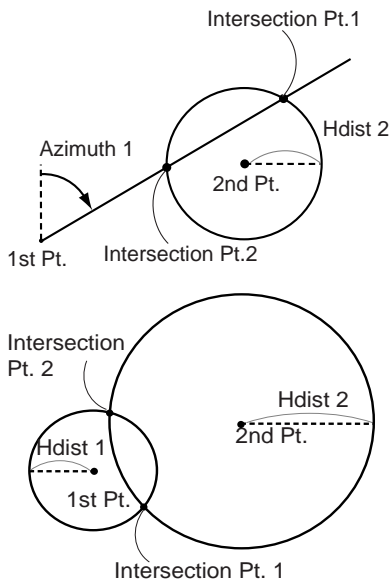

► PROCEDURE

1. In the second page of the Meas mode screen, press **[MENU]**, then select "Intersections".
2. Enter the 1st point data and press **[NEXT]**.

Intersections	▲
Traverse	

Define 1st Pt.	
Np:	113.464
Ep:	91.088
Zp:	12.122
READ	REC OBS NEXT

18. INTERSECTIONS

- When **[READ]** is pressed, registered coordinates can be recalled and used.
- ☞ "12.1 Entering Instrument Station Data and Azimuth Angle PROCEDURE Reading in Registered Coordinate Data"
- **[REC]**: records the coordinate value as a known point data.

N	rec 3991
E	113.464
Z	91.088
Pt.	12.122
	5

- Press **[OBS]** to observe the selected point.

3. Enter the 2nd point data and press **[OK]**.

- Press **[OBS]** to observe the selected point.

Define 2nd Pt.	
Np:	112.706
Ep:	104.069
Zp:	11.775
READ REC OBS OK	

4. Enter azimuth angle (or horizontal distance) of the 1st point and 2nd point.



Both the azimuth angle and horizontal distance of the 1st (or 2nd) point cannot be input.

- When the cursor is on "Azimuth1" or "Azimuth2", **[COORD]** is displayed. Press **[COORD]** to set the azimuth angle for each point by inputting coordinates.

Azimuth1:	45° 00' 00"
H.dist1:	<Null>
Azimuth2:	
H.dist2:	50.000m
COORD	OK

- Press **[OBS]** to observe the selected point.

1st Pt.	
Np:	0.000
Ep:	0.000
Zp:	<Null>
READ REC OBS NEXT	

5. Press **[OK]**. The coordinate value of the intersection point is calculated and displayed.

```
Azmth1 : 45° 00' 00"
H.dist1 : <Null>
Azmth2 : <Null>
H.dist2 : 50.000m
OK
```

```
Intersection1
N      176.458
E      176.458
Z      <Null>
OTHER REC S-O
```

- When there are 2 intersections, **[OTHER]** is displayed.
 "2 Intersections"

- Press **[▲ S-O]** to move to setting-out measurement of the required point.
 "14. SETTING-OUT MEASUREMENT"

6. Press **{ESC}**. Continue the measurement (repeat steps from 2).

Note

- It is also possible to perform intersection measurement by pressing **[INTSCT]** when allocated to the Meas mode screen.
 Allocating **[INTSCT]**: "28.3 Allocating Key Functions"



2 Intersections

2 intersections are defined according to 1st Pt. and 2nd Pt. as shown below
 Intersections created from Azmth 1 and H.dist 2 (or H.dist 1 and Azmth 2):
 An azimuth angle has already been set for a point. The furthest point from this point is set as Intersection Pt. 1, and the closest point set as Intersection Pt. 2.

- Intersections created from H.dist 1 and H.dist 2:
 Intersection to the right of the straight line between 1st point and 2nd point set as Intersection Pt. 1 and the point to the left set as Intersection Pt. 2.

18. INTERSECTIONS



Precaution when performing intersection measurement

In the following cases the coordinates of intersection points cannot be calculated.

When Azimuth 1 = Azimuth 2.

When Azimuth 1 – Azimuth 2 = $\pm 180^\circ$.

When H.dist 1 = 0, or H.dist 2 = 0.

When the coordinates for 1st Pt. and 2nd Pt are the same.

19. TRAVERSE ADJUSTMENT

Measurement of a traverse begins with observation of the backsight station and foresight station. The instrument station is then moved to the foresight station and the previous instrument station becomes the backsight station. Observation is performed again at the new position. This process is repeated for the length of the route.

This adjustment function is used to calculate the coordinates of such a sequence of consecutively-observed points (traverse points and points observed from traverse points (see P3-1 to P3-3 below)). When calculation is complete, the SET displays the precision of the traverse and, when necessary, traverse adjustment can be performed.

☞ For types of traverse that can be calculated with the SET, see "☞ Types of traverse"

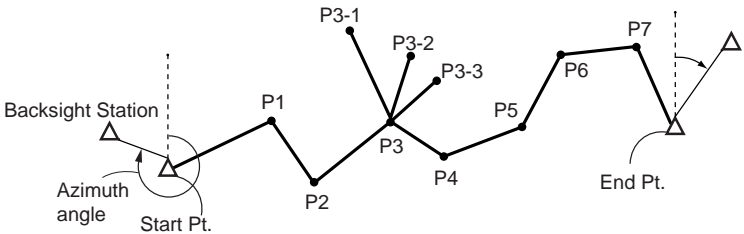

►PROCEDURE

1. Before starting traverse calculation, observe the sequence of traverse points and record the results.

☞ "23.4 Recording Distance Measurement Data"/
"23.6 Recording Distance and Coordinate Data"

2. In the second page of the Meas mode screen, press [MENU], then select "Traverse".



19. TRAVERSE ADJUSTMENT

3. Enter the start point name and press **[←]**.

- When **[LIST]** is pressed, a list of instrument stations saved in the current JOB is displayed. A point from this list can be recalled and used.

 For using softkeys in this screen, see "12.1 Entering Instrument Station Data and Azimuth Angle PROCEDURE Reading in Registered Coordinate Data"

- Enter values manually when there are no coordinates saved for the specified instrument station.
Press **[OK]** to proceed to step 4.

4. Enter the point name of the backsight station for the start point and press **[←]**.

Traverse start pt.
Stn:
Bs :
Azimuth: <Null>
[LIST] **[OK]**

Stn T-0001
Stn T-0002
Stn T-0003
Stn T-0004
Stn T-0005
[I]...P **[TOP]** **[LAST]** **[SRCH]**

Stn:
N 0.000
E 0.000
Z <Null>
Pt. T-0001
[READ] **[REC]** **[OK]**

Traverse start pt.
Stn:T-0001
Bs : BS
Azimuth: <Null>
[LIST] **[OK]**

When there are saved coordinates for the backsight station, the calculated azimuth angle is displayed.

- Enter values manually when there are no coordinates saved for the specified start point backsight station.
Press **[OK]** to display the calculated azimuth angle.
- To enter azimuth angle without entering backsight station coordinates, press **{▼}** to move the cursor down to "Azimuth" then enter an angle value.

```

Traverse start pt.
Stn:T-0001
Bs :T-000Z
Azimuth: 357° 27' 46"
[OK]

```

5. When **[OK]** is pressed in the screen in step 4, the SET will search for a traverse route. The points from step 1 will be displayed in the order in which they were observed.

```

001:T-0001
Searching

```

- This search can be stopped by pressing **{ESC}**. If **{ESC}** is pressed, a route can be computed using only the points found prior to the search being stopped.
- When a traverse point with recorded known point coordinates is found, or there are multiple foresight stations for a point, the automatic route search will stop. Press **[LIST]** and select which foresight station to use as the next point.
[F] "Automatic route search"

```

Exit Searching
confirm?
[NO] [YES]

```

19. TRAVERSE ADJUSTMENT

6. Press **[OK]** to confirm the traverse route.

006:T-0006	▲
007:T-0007	
008:T-0001	
009: [REDACTED]	
LIST	OK

7. Enter the point name of the backsight station for the end point and press **[←]**.

The calculated azimuth angle is displayed.

Traverse end pt.	
Stn:T-0001	
Fs:T-0002	[REDACTED]
Azimuth:	335°27'46"
LIST	OK

Enter the azimuth angle when there are no recorded coordinates for the end point backsight station.

8. When **[OK]** is pressed in the screen in step 7, the SET will display the precision of the traverse.

Traverse precision	
d.Ang :	0°00'20"
d.Dist :	0.013
Precision :	42714 ▼
OPTION	ADJUST

Traverse precision ▲	
d.North :	0.013
d.East :	0.000
d.Elev :	-0.002
OPTION	ADJUST

d.Ang: Angular closure error

d.Dist: Horizontal closure distance

Precision: Precision of the traverse as a ratio of the total horizontal distance traversed to the closure distance

d.North: Closure distance in Northing coordinates

d.East: Closure distance in Easting coordinates

d.Elev: Closure distance in elevation

- Press **[OPTION]** to change the method by which the traverse adjustments are distributed.

(*:Factory setting)

- (1) Method (coordinate adjustment):
Compass*, Transit
- (2) Angular:
Weighted*, Linear, None
- (3) Elev (Elevation):
Weighted*, Linear, None

 For all options, see "Adjustment methods"

9. Angular adjustment will be performed first. Press **[ADJUST]** to start adjustment using the method selected in "(2) Angular" in step 8.

- When "None" is selected in "(2) Angular" in step 8, only coordinate and elevation adjustment will be performed.

10. After confirming the results, press **[ADJUST]** again to start coordinate and elevation adjustment using the methods selected in "(1) Method" and "(3) Elev" respectively. All adjusted instrument data will be saved in the currently selected JOB and traverse adjustment will be finished.

Adjustment options

Method : **Compass**
Angular : Weighted
Elev : Weighted

After angle adjust

d.Ang : 0°00'00"
d.Dist : 0.006
precision: 89788 ▼
OPTION **ADJUST**

Traverse adjustment

Recording... 7

19. TRAVERSE ADJUSTMENT

Note

- It is also possible to perform traverse adjustment by pressing **[TRAVER]** when allocated to the Meas mode screen.

 Allocating **[TRAVER]**: "28.3 Allocating Key Functions"

- Traverse adjustment results of traverse points, points observed from traverse points and traverse adjustment data will be saved in the currently selected JOB as Notes data. Data including the distributed closure error will also be saved in the currently selected JOB as ordinary coordinate data.

Traverse line record (3):

1. point names of start and end points
2. backsight station name and azimuth to said backsight station
3. foresight station name and azimuth to said foresight

Adjustment setting record (1):

The selected method for distributing closure error.

Closure error record (2x2):

1. precision and closure error for angle/
distance
2. coordinate closure error

Coordinate adjustment record

(No. of included points between start and end points):

Coordinates



Types of traverse

SET can calculate closed-loop and closed traverses. In both cases, the azimuth for the start point (and for the end point in the case of a closed traverse) must be set.

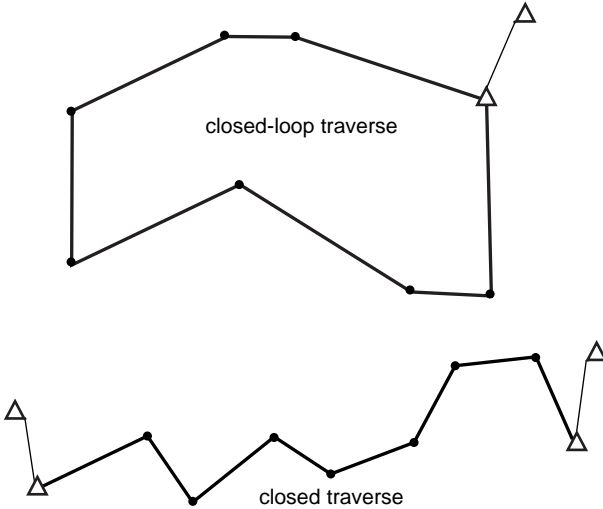

Automatic route search

This function searches for consecutively-observed traverse points already stored on the SET and presents them as potential traverse routes.

This function is activated when the following conditions are met. When a point has been observed more than once, the most recent data will be used for the search.

- At least one backsight station and one foresight station are observed from an instrument station.
- The foresight station becomes the instrument station for the subsequent measurement.
- The instrument station becomes the backsight station for the subsequent measurement.

19. TRAVERSE ADJUSTMENT

If one of the following conditions is met, the automatic route search will terminate. The same search can be resumed by specifying the name of the next point in the route.

- There is more than one potential foresight station for an instrument station. (Route search terminates as a juncture appears in the route.)
- The foresight station for the previous measurement was the Start pt. (Route search terminates as this measurement is judged to have closed a closed-loop traverse.)
- The most recently measured point has the same point name as a recorded known point. (Route search terminates as this point is judged to be the End pt.)

The automatic route search function cannot be used in the following case.

- The final measurement is to a traverse point on the traverse route other than the Start pt.



Adjustment methods

Adjustment is applied to results for traverse points and points observed from traverse points.

Adjustment methods and distribution options selected in step 8 are described below.

Method

Compass: The Compass method distributes the coordinate error in proportion to the length of the traverse lines.

$$\text{Northing adjustment} = \frac{L}{TL} \times \text{closure north}$$

$$\text{Easting adjustment} = \frac{L}{TL} \times \text{closure east}$$

Where: L = length of the traverse line to the point
TL = sum of the traverse line lengths

Transit: The Transit method distributes the coordinate error in proportion to the northing and easting ordinates of each traverse line.

$$\text{Northing adjustment} = \frac{|\Delta N|}{\Sigma |\Delta N|} \times \text{closure north}$$

$$\text{Easting adjustment} = \frac{|\Delta E|}{\Sigma |\Delta E|} \times \text{closure east}$$

Where: ΔN = change in northing for the traverse line
 ΔE = change in easting for the traverse line
 $\Sigma |\Delta N|$ = sum of the absolute value of all the changes in northings of all the traverse lines
 $\Sigma |\Delta E|$ = sum of the absolute value of all the changes in eastings of all the traverse lines

Angular adjustment

Weighted: Any angular closure is distributed among the angles of the traverse route based on the sum of the inverses of the forward and back traverse line lengths at each angle. The backsight and foresight lines are considered to have infinite lengths for the purposes of this weighting computation.

$$\angle \text{adjustment} = \frac{\left(\frac{1}{\text{todist}} + \frac{1}{\text{fromdist}} \right)}{\Sigma \left(\frac{1}{\text{todist}} + \frac{1}{\text{fromdist}} \right)} \times \angle \text{closure}$$

Linear: Any angular closure is distributed evenly among the angles of the traverse route.

None: No angular adjustment performed.

Elev adjustment

Weighted: Any closure in the elevations is distributed in proportion to the length of the traverse line leading to the point (like the Compass method for coordinate adjustment).

Linear: Any closure in the elevations is distributed evenly in each leg of the traverse route.

None: No elevation adjustment performed.

20. OFFSET MEASUREMENT

Offset measurements are performed in order to find a point where a target cannot be installed directly or to find the distance and angle to a point which cannot be sighted.

- It is possible to find the distance and angle to a point you wish to measure (target point) by installing the target at a location (offset point) a little distance from the target point and measuring the distance and angle from the survey point to the offset point.
- The target point can be found in the three ways explained below.

20.1 Single-distance Offset Measurement

Finding it by entering the horizontal distance from the target point to the offset point.

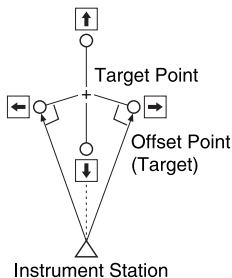

- When the offset point is positioned to the left or right of the target point, make sure the angle formed by lines connecting the offset point to the target point and to the instrument station is almost 90° .
- When the offset point is positioned in front of or behind the target point, install the offset point on a line linking the instrument station with the target point.

► PROCEDURE

1. Set the offset point close to the target point and measure the distance between them, then set up a prism on the offset point.

2. Sight the offset point and press **[DIST]** in the first page of the Meas mode screen to begin measurement.
The measurement results are displayed. Press **[STOP]** to stop the measurement.
3. Press **[OFFSET]** in page three of Meas mode to display <Offset>.
4. Enter the instrument station data.
 "12.1 Entering Instrument Station Data and Azimuth Angle PROCEDURE Reading in Registered Coordinate Data".

5. Select "Offset/Dist".

Input the following items.

- (1) Horizontal distance from the target point to the offset point.
- (2) Direction of the offset point.

- Direction of offset point

← : On the left of the target point.

→ : On the right of the target point.

↓ : Closer than the target point.

↑ : Beyond the target point.

- Press **[OBS]** to re-observe the offset point.

6. Press **[OK]** on the screen of step 5 to calculate and display the distance and angle of the target point.

```

Offset
Stn. Orientation
Offset/Dist
Offset/Angle
Offset/2D
  
```

```

S      34 770m
ZA     80°30'10"
HAR    120°10'00"
Dist:  2.000m
Direc: →
OBS      OK
  
```

```

Offset / Dist
S      34.980m
ZA     85°50'30"
HAR    125°30'20"
REC  XYZ  NO  YES
  
```

20. OFFSET MEASUREMENT

7. Press **[YES]** to return to <Offset>.

- Press **[XYZ]** to switch the screen display from distance values to coordinate values. Press **[HVD]** to return to distance values.
- Press **[NO]** to return to the previous distance and angle.
- To record the calculation result, press **[REC]**.

 "23. RECORDING DATA - RECORD MENU -"

20.2 Angle Offset Measurement

Sighting the direction of the target point to find it from the included angle. Install offset points for the target point on the right and left sides of and as close as possible to the target point and measure the distance to the offset points and the horizontal angle of the target point.

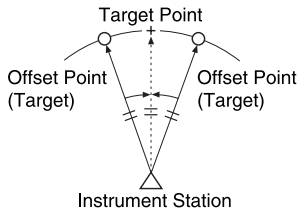

► PROCEDURE

1. Set the offset points close to the target point (making sure the distance from the instrument station to the target point and the height of the offset points and the target point are the same), then use the offset points as the target.

20.3 Two-distance Offset Measurement

By measuring the distances between the target point and the two offset points. Install two offset points (1st target and 2nd target) on a straight line from the target point, observe the 1st target and 2nd target, then enter the distance between the 2nd target and the target point to find the target point.

- It is possible to make this measurement easily using the optional equipment: the 2-point target (2RT500-K). When using this 2-point target, be sure to set prism constant to 0.

 "28.1 EDM Settings"

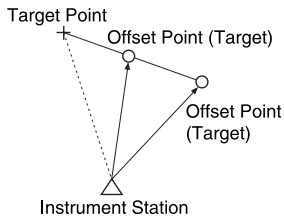

How to use 2-point target (2RT500-K)

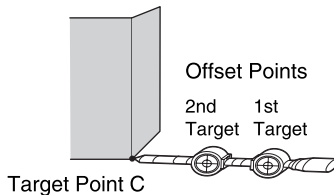

- Install the 2-point target with its tip at the target point.
- Face the targets toward the instrument.
- Measure the distance from the target point to the 2nd target.
- Set the reflector type to "sheet".

► PROCEDURE

1. Install two offset points (1st target, 2nd target) on a straight line from the target point and use the offset points as the target.

2. Press **[OFFSET]** in page three of Meas mode to display <Offset>.

3. Enter the instrument station data.
 "12.1 Entering Instrument Station Data and Azimuth Angle PROCEDURE Reading in Registered Coordinate Data"

4. Select "Offset/2D" in <Offset>.

```
Offset
Stn. Orientation
Offset/Dist
Offset/Angle
Offset/2D
```

5. Sight the 1st target and press **[OBS]**.

Observation begins and the measurement results are displayed.

Press **[YES]**. The "2nd Target Observation Screen" is displayed.

```
Observe 1st o/s
ZA 73° 18' 00"
HAR 250° 12' 00"
OBS
```

6. Sight the 2nd target and press **[OBS]**.

The measurement results are displayed. Press **[YES]**.

```
N 10.480
E 20.693
Z 15.277
Confirm?
NO YES
```

7. Enter the distance from the 2nd target to the target point and press **[←]**. The coordinates of the target point are displayed.

```
B-C: 1.2000m
```

```
Offset/2D
N 10.480
E 20.693
Z 15.277
REC HVD NO YES
```

20. OFFSET MEASUREMENT

8. Press **[YES]**. <Offset> is restored.
 - When **[HVD]** is pressed, display mode is switched from coordinates to S, ZA, HAR.

21. MISSING LINE MEASUREMENT

Missing line measurement is used to measure the slope distance, horizontal distance, and horizontal angle to a target from the target which is the reference (starting point) without moving the instrument.

- It is possible to change the last measured point to the next starting position.
- Measurement result can be displayed as the gradient between two points.

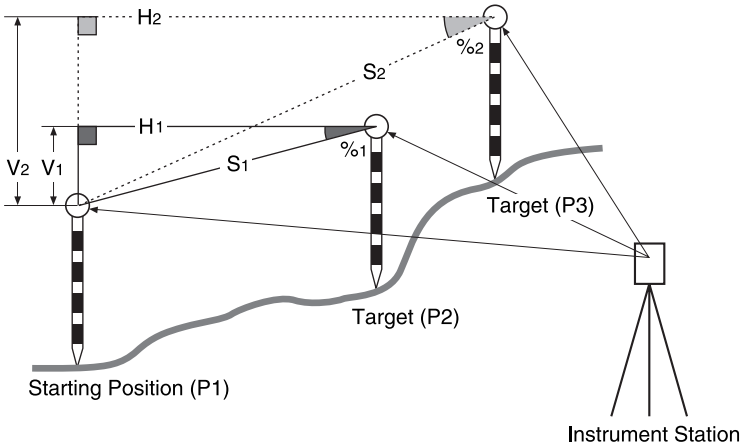

21.1

Measuring the Distance between 2 or more Points

The distance between two or more points can either be measured by observing the targets in question or calculating from input coordinates. A combination of these two methods (e.g. observing the 1st target and inputting 2nd target coordinates) is also possible.

21. MISSING LINE MEASUREMENT

►PROCEDURE Measuring using observation

1. In the third page of Meas mode screen, press **[MLM]**, then select "MLM".

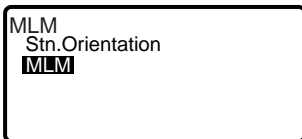

2. Sight the 1st target and press **[OBS]**.

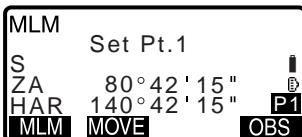

3. Sight the second target and press **[MLM]** to begin observation.

- **[REC]**: records 1st target measurement results.

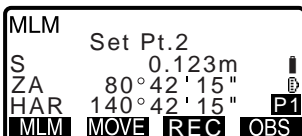

The following values are displayed:

S : Slope distance of the starting position and 2nd target.

H : Horizontal distance of the starting position and 2nd position.

V : Height difference of the starting position and 2nd target.

- Target height of the starting position and 2nd target can be input.

Press **[TARGET]** on the second page.

Input the target heights and press **[OK]**.

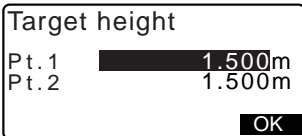
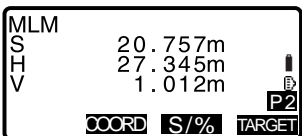
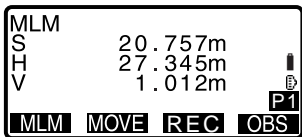

- Press **[COORD]** to input coordinates.
 "PROCEDURE
 Calculating from input coordinates"
- Press **[REC]** to record 2nd target measurement results and display the screen at right.

Press **[OK]** to record missing line measurement results and return to the results screen.

Press **(ESC)** to continue measurement without saving 2nd target or missing line measurement results.

N	10.000
E	20.000
Z	30.000
Cd	1010
Tat.h	1.500m
OK ADD LIST SRCH	

H	27.345m
V	1.012m
Cd	1010
Pt.1	2
Pt.2	3
OK ADD LIST SRCH	

MLM	
S	20.757m
H	27.345m
V	1.012m
MLM MOVE OBS	



- Missing line measurement results cannot be recorded when point names for 1st and/or 2nd target are null. Always input point names for both targets.

21. MISSING LINE MEASUREMENT

4. Sight the next target and press **[MLM]** to begin observation. Slope distance, horizontal distance and height difference between multiple points and the starting position can be measured this way.

- When **[S/%]** is pressed, the distance between two points (S) is displayed as the gradient between two points.
- Press **[OBS]** to re-observe the starting position. Sight the starting position and press **[OBS]**.
- When **[MOVE]** is pressed, the last target measured becomes the new starting position to perform missing line measurement of the next target.

 "21.2 Changing the Starting Point"

5. Press **{ESC}** to end missing line measurement.

►PROCEDURE Calculating from input coordinates

1. In the third page of Meas mode screen, press **[MLM]**, then select "MLM".



MLM
Stn.Orientation
[MLM]

2. Press **[COORD]** on the second page.

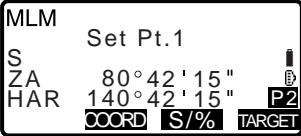

MLM Set Pt. 1
S
ZA 80°42'15" 
HAR 140°42'15" **[P2]**
[COORD] **[S/%]** **[TARGET]**

3. Input coordinates for the 1st target and press **[OK]**.

- When you wish to read in and set coordinate data from memory, press **[READ]**.

 "12.1 Entering Instrument Station Data and Azimuth Angle"

		Pt.1	
N	<input type="text"/>	20.000	
E	<input type="text"/>	30.000	
Z	<input type="text"/>	40.000	
[READ]		[REC]	[OK]

4. Select "Pt.2" and press **{←}** to proceed to 2nd target input.

MLM		
Pt.1		
[Pt.2]		

5. Input coordinates for the 2nd target and press **[OK]**.

The following values are displayed:

- S : Slope distance of the starting position and 2nd target.
 H : Horizontal distance of the starting position and 2nd position.
 V : Height difference of the starting position and 2nd target.
- Target height of the starting position and 2nd target can be input.

Press **[TARGET]** on the second page.

Input the target heights and press **[OK]**.

MLM			
S	<input type="text"/>	20.757m	
H	<input type="text"/>	27.345m	
V	<input type="text"/>	1.012m	
[MLM]		[MOVE]	[REC] [P1]
		[OBS]	

Target height		
Pt.1	<input type="text"/>	1.500m
Pt.2	<input type="text"/>	1.500m
		[OK]

21. MISSING LINE MEASUREMENT

- Press **[COORD]** to re-input coordinates for the first or 2nd targets.
- **[REC]**: records missing line measurement results.
- When **[S/%]** is pressed, the distance between two points (S) is displayed as the gradient between two points.
- Press **[OBS]** to observe the starting position.
 "PROCEDURE Measuring using observation"
- When **[MOVE]** is pressed, the last target measured becomes the new starting position to perform missing line measurement of the next target.

 "21.2 Changing the Starting Point"

Press **{ESC}** to end missing line measurement



Missing line measurement results cannot be recorded when point names for 1st and/or 2nd target are null. Always input point names for both targets.

21.2 Changing the Starting Point

It is possible to change the last measured point to the next starting position.

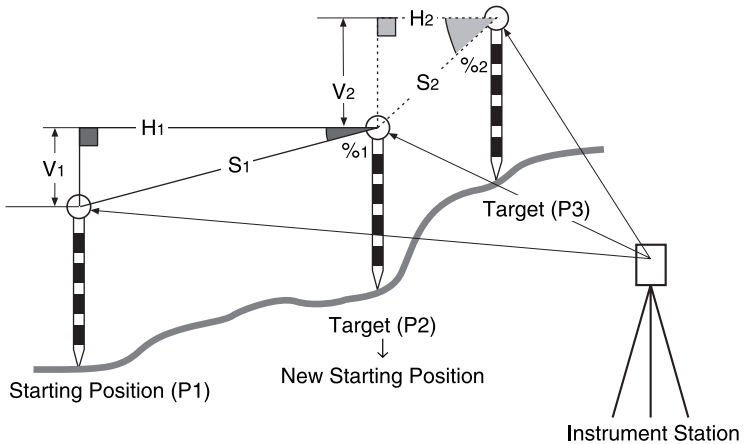

► PROCEDURE

1. Observe the starting position and target.
 "21.1 Measuring the Distance between 2 or more Points"
2. After measuring the targets, press **[MOVE]**.
 Press **[YES]**.
 - Press **[NO]** to cancel measurement.

MLM	
S	20.757m
H	27.345m
V	1.012m
MLM MOVE REC OBS	

MLM	Move 1st obs ?
S	34.980m
ZA	85° 50' 30"
HAR	125° 30' 20"
NO YES	

21. MISSING LINE MEASUREMENT

3. The last target measured is changed to the new starting position.

Perform missing line measurement.

-  "21.1 Measuring the Distance between 2 or more Points".

22. SURFACE AREA CALCULATION

You can calculate the area of land (slope area and horizontal area) enclosed by three or more known points on a line by inputting the coordinates of the points.

Input

Coordinates : P1 (N1, E1, Z1)

...

P5 (N5, E5, Z5)

Output

Surface area: S (slope area and horizontal area)

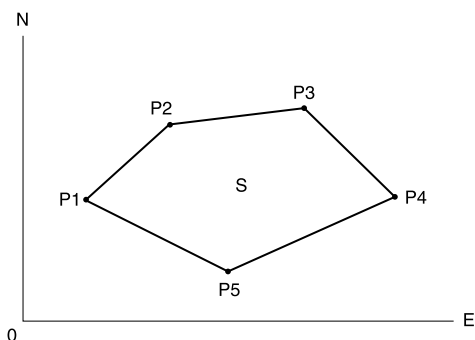

- Number of specified coordinate points: 3 or more, 50 or less
- Surface area is calculated by observing the points on a line enclosing an area in order or reading in the previously registered coordinates in order.



- If two or less points are used to measure an area, an error will occur.
- Be sure to observe (or recall) points on an enclosed area in a clockwise or counterclockwise direction. For example, the area specified by entering (or recalling) point numbers 1, 2, 3, 4, 5 or 5, 4, 3, 2, 1 implies the same shape. However, if points are not entered in numerical order, the surface area will not be calculated correctly.



Slope area

The first three points specified (measured/read-in) are used to create the surface of the slope area. Subsequent points are projected vertically onto this surface and the slope area calculated.

22. SURFACE AREA CALCULATION

►PROCEDURE Surface area calculation by observing points

1. In the second Meas mode screen, press **[MENU]**, then select "Area calculation".

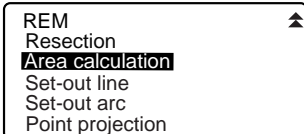

```
REM
Resection
Area calculation
Set-out line
Set-out arc
Point projection
```

2. Enter the instrument station data.

 "12.1 Entering Instrument Station Data and Azimuth Angle PROCEDURE Reading in Registered Coordinate Data"

3. Select "Area calculation" in <Area calculation>.

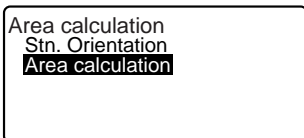

```
Area calculation
Stn. Orientation
Area calculation
```

4. Sight the first point on the line enclosing the area, and press **[MEAS]**. Press **[OBS]** to begin observation. The measured values are displayed.



```
01:
02:
03:
04:
05:
READ MEAS
```

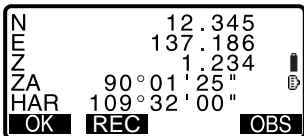

```
N      12.345
E      137.186
Z      1.234
ZA     90°01'25"
HAR    109°32'00"
OK REC OBS
```

5. Press **[OK]** to enter the value of the first point in "01".
- Press **[REC]** in the second screen of step 4 to record code, target height, and point number. The point number recorded here will be displayed in "01".

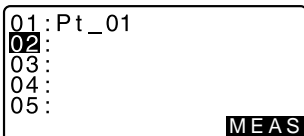

```
01: Pt_01
02:
03:
04:
05:
MEAS
```

22. SURFACE AREA CALCULATION

6. Repeat steps 4 to 5 until all points have been measured. Points on an enclosed area are observed in a clockwise or counterclockwise direction.

For example, the area specified by entering point numbers 1, 2, 3, 4, 5 or 5, 4, 3, 2, 1 implies the same shape.

After all known points necessary to calculate the surface area have been observed, **[CALC]** is displayed.

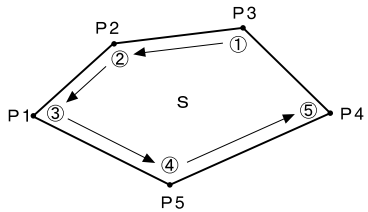

7. Press **[CALC]** to display the calculated area.

Pt.: number of set points

SArea: slope area

HArea: horizontal area

01: Pt_01		
02: Pt_02		
03: Pt_03		
04: Pt_04		
05:		
	CALC	MEAS

Pt .3		
SArea	468.064m ²	
	0.0468ha	
HArea	431.055m ²	
	0.0431ha	
	REC	OK

8. Press **[REC]** in the screen of step 7 to record results and return to <Menu>.

Press **[OK]** to return to <Menu> without recording results.

22. SURFACE AREA CALCULATION

► PROCEDURE Surface area calculation by reading in the points' coordinates

1. In the second Meas mode screen, press **[MENU]**, then select "Area calculation".
2. Enter the instrument station data.
3. Select "Area calculation" in <Area calculation>.

4. Press **[READ]** to display the list of coordinate data.

Pt. : Known point date saved in the current JOB or in the Coordinate Search JOB.

Crd./ Stn : Coordinate data saved in the current JOB or in the Coordinate Search JOB.

```
01:
02:
03:
04:
05:
READ MEAS
```

5. Select the first point in the list and press **{←}**.

The coordinates of the first point is set as "Pt.001".

```
Pt. Pt.001
Pt. Pt.002
Pt. Pt.004
Pt. Pt.101
Pt. Pt.102
P TOP LAST SRCH
```

6. Repeat steps 4 to 5 until all points have been read in.

Points on an enclosed area are read in a clockwise or counterclockwise direction. After all known points necessary to calculate the surface area have been observed, **[CALC]** is displayed.

```
01:Pt.004
02:
03:
04:
05:
READ
```

7. Press **[CALC]** to display the calculated area.

Pt.3	
SArea	468.064m ²
	0.0468ha
HArea	431.055m ²
	0.0431ha
REC	OK

8. Press **[REC]** in the screen of Step 7 to record results and return to <Menu>.
Press **[OK]** to return to <Menu> without recording results.

Note

- It is also possible to perform area measurement by pressing **[AREA]** when allocated to the Meas mode screen.
 Allocating **[AREA]**: "28.3 Allocating Key Functions"

23. RECORDING DATA - RECORD MENU -

In Record menu, you can store the measurement data (distance, angle, coordinates), station point data, backsight station data, and note in the current JOB.

"24. SELECTING/DELETING A JOB"

- A total of 10000 data can be stored inside the instrument. Recording instrument station data and backsight station data is an exception.

Note

- If the same point number is input, the following screen is displayed.

N	5.544
E	-0.739
Z	0.245
Pt.	PNT-001
	Overwrite ?
ADD	NO YES

Press **[ADD]** to record the point as another record with the same name.

Press **[NO]** to input a new name.

Press **[YES]** to overwrite the present point.

23.1 Recording Instrument Station Data

Instrument station data can be stored in the current JOB.

- The items that can be recorded are the instrument station coordinates, point number, instrument height, codes, operator, date, time, weather, wind, temperature, air pressure and atmospheric correction factor.
- If instrument station data is not stored for the current JOB, the previously stored instrument data settings will be used.

► PROCEDURE

1. Press **[REC]** in the third page of Meas mode to display <REC>.
 - Current JOB name is displayed.

2. Select "Stn. data".

- Select **[READ]** to recall and use the registered coordinates.

 "12.1 Entering Instrument Station Data and Azimuth Angle PROCEDURE Reading in Registered Coordinate Data".

REC_JOB1
Stn. data
Backsight data
Angle data
Dist data
Coord data

3. Set the following data items.

- (1) Instrument station coordinates
- (2) Point number
- (3) Instrument height
- (4) Code
- (5) Operator
- (6) Date
- (7) Time
- (8) Weather
- (9) Wind
- (10) Temperature
- (11) Air pressure
- (12) Atmospheric correction factor

N0 :	56.789
E0 :	-1234567.789
Z0 :	1.234
Pt. Pt.	004
Inst.h	1.234m
OK	READ

- When inputting code, **[ADD]**, **[LIST]** and **[SRCH]** are displayed.

Press **[ADD]** to save input codes in memory.

Press **[LIST]** to display saved codes in reverse chronological order.

Press **[SRCH]** to search for a saved code.

Code	↑
: pole	A
Operator :	↓
: SOKKIA	
OK	ADD LIST SRCH

Date	: Jan/28/2003	↑
Time	: 17:02:33	
Weath :	Fine	↓
Wind	: Calm	
OK		

 For reviewing and saving codes in Memory mode, see "25.3 Registering/Deleting Codes" and "25.4 Reviewing Codes"

Temp. :	12 °C	↑
Press. :	1013hPa	
ppm	: -3	↓
OK	0ppm	

23. RECORDING DATA - RECORD MENU -

- To set the atmospheric correction factor to 0ppm, press **[0ppm]**. The temperature and air pressure are set to the default setting.
4. Check the input data, then press **[OK]**.
 5. Press **{ESC}** to restore <REC>.

Note

- Maximum point number size: 14 (alphanumeric)
- Input range of instrument height: -9999.999 to 9999.999 (m)
- Maximum code/operator size: 16 (alphanumeric)
- Weather selection: Fine, Cloudy, Light rain, Rain, Snow
- Wind selection: Calm, Gentle, Light, Strong, Very strong
- Temperature range: -30 to 60 (°C) (in 1°C step)/-22 to 140 (°F) (in 1°F step)
- Air pressure range: 500 to 1400 (hPa) (in 1 hPa step)/375 to 1050 (mmHg) (in 1mmHg step)/14.8 to 41.3 (inch Hg) (in 0.1 inch Hg step)
- Atmospheric correction factor range (ppm): -499 to 499

Date: Entry example	July 20, 2006 → 20060720
Time:Entry example:	2:35:17 p.m. → 143517

23.2 Recording Backsight Point

Backsight station data can be stored in the current JOB. Azimuth angle setting method can be selected from “inputting azimuth angle” or “calculating coordinates”.

► PROCEDURE Inputting azimuth angle

1. Press **[REC]** in the third page of Meas mode to display <REC>.
2. Select “Backsight data”.

```
REC JOB1
  Stn. data
  Backsight data
  Angle data
  Dist data
  Coord data
```



3. Select "Angle".
Angle measurement values are displayed in real time.

```
REC / Backsight
Angle
Coord
```

4. Input Azimuth angle.

```
REC/Backsight
Take BS
ZA 90° 12' 34"
HAR 130° 12' 34"
HAR: [REDACTED] [REC]
```

5. Sight the backsight and press **[REC]** in the screen of step 4, and set the following items.

```
ZA 90° 12' 34" [A]
HAR 0° 00' 00"
Cd [REDACTED]
Tgt.h 0.000m [v]
[OK] [ADD] [LIST] [SRCH]
```

- (1) Code
(2) Target height
(3) Point number

6. Check the input data, then press **[OK]** to set the backsight station.
<REC> is restored.

```
Pt. [REDACTED] 1 [A]
[OK]
```

►PROCEDURE Calculating azimuth angle by coordinates

1. Press **[REC]** in the third page of Meas mode to display <REC>.
2. Select "Backsight data".
3. Select "Coord".

```
REC / Backsight
Angle
Coord
```

23. RECORDING DATA - RECORD MENU -

4. Input the backsight station coordinates.

- When you wish to read in and set coordinate data from memory, press **[READ]**.

 "12.1 Entering Instrument Station Data and Azimuth Angle PROCEDURE Reading in Registered Coordinate Data"

REC/Backsight	
NBS :	1.000
EBS :	1.000
ZBS :	<Null>
[READ]	[OK]

5. Press **[OK]** in the screen of step 4. Angle measurement values are displayed in real time. Calculated Azimuth angle is also displayed.

REC/Backsight	
Take BS	
ZA	90° 12' 34"
HAR	123° 12' 34"
Azmth:	45° 00' 00"
	[REC]

6. Sight the backsight and press **[REC]** in the screen of step 4, and set the following items.

- (1) Code
- (2) Target height
- (3) Point number

ZA	90° 12' 34"	[A]
HAR	45° 00' 00"	
Cd		
Tgt.h	0.000m	▼
[OK]	[ADD]	[LIST] [SRCH]

7. Check the input data, then press **[OK]** to set the backsight station. <REC> is restored.

Pt.	1	▲
		[A]
[OK]		

23.3 Recording Angle Measurement Data

Angle measurement data can be stored in the current JOB.

- It is convenient to use **[AUTO]** to perform automatic operation from angle measurement to recording.

►PROCEDURE

1. Press **[REC]** in the third page of Meas mode to display <REC>.
2. Select "Angle data" and sight the point to be recorded.
Angle measurement values are displayed in real time.
3. Press **[REC]** in the screen of step 2, and set the following items.
 - (1) Code
 - (2) Target height
 - (3) Point number
4. Check the input data, then press **[OK]**.
5. To continue measurement, sight the next point, then perform steps 3 and 4 above.

```
REC JOB1
  Stn. data
  Backsight data
  Angle data
  Dist data
  Coord data
```

```
REC/Angle   rec 2922
ZA      60°15'40"
HAR    110°30'45"
Pt. Pt.002
[AUTO] [0SET] [REC]
```

```
ZA      60°15'40"
HAR    110°30'45"
Cd 1010
Tgt.h   1.234m
[OK] [ADD] [LIST] [SRCH]
```

```
Pt. Pt.002
[OK]
```

23. RECORDING DATA - RECORD MENU -

- Press **[AUTO]** to perform angle measurement and automatically record the results. **[AUTO]** is convenient for recording measurement data when point number, code, and target height are not set.

```
REC/Angle      rec 2923
ZA      80°30'15"
HAR     120°10'00"
Pt.     Pt.001
        Recorded
```

6. Press **{ESC}** to quit measurement and restore <REC>.

23.4 Recording Distance Measurement Data

Distance measurement data can be stored in the current JOB.

► PROCEDURE

1. Press **[DIST]** in the first page of Meas mode to perform distance measurement.
 "11.2 Distance and Angle Measurement"

2. Press **[REC]** in the third page of Meas mode. <REC> is displayed. Select "Dist data" to display the measurement results.

```
REC JOB1
Stn. data
Backsight data
Angle data
Dist data
Coord data
```

```
REC/Dist      rec 2922
S      123.456m
ZA      80°30'15"
HAR     120°10'00"
Pt.     1
[AUTO] [DIST] [OFFSET] [REC]
```

3. Press **[REC]** in the screen of step 2, and set the following items.
 - (1) Code
 - (2) Target height
 - (3) Point number

```
S      123.456m
ZA      80°30'15"
HAR     120°10'00"
Cd      ██████████
Tgt.h     1.234m
[OK] [ADD] [LIST] [SRCH]
```

4. Check the input data, then press **[OK]**.
5. To continue measurement, sight the next point, press **[DIST]**, then perform steps 3 and 4 above.

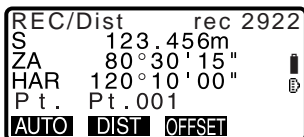

- Press **[OFFSET]** to offset measurement in Record Mode.

6. Press **{ESC}** to quit measurement and restore <REC>.

Note

- Once the data has been recorded, **[REC]** is not displayed in order to prevent double recording.

23.5 Recording Coordinate Data

Coordinate data can be stored in the current JOB

► PROCEDURE

1. Perform coordinates measurement in the Meas mode screen.
 "12. COORDINATE MEASUREMENT"

23. RECORDING DATA - RECORD MENU -

- Press **[REC]** in the third page of Meas mode to display <REC>. Select "Coord data" to display the measurement results.

```
REC JOB1
  Stn. data
  Backsight data
  Angle data
  Dist data
  Coord data
```

- Press **[REC]** in the screen of step 2, and set the following items.
 - Code
 - Target height
 - Point number

```
REC/Coord   rec 2923
N           344.284
E           125.891
Z           15.564
Pt.   Pt.003
[AUTO] [OBS] [OFFSET] [REC]
```

- Check the input data, then press **[OK]**.
- To continue measurement, sight the next point, press **[OBS]**, then perform steps 3 and 4 above.
- Press **{ESC}** to quit measurement and restore <REC>.

```
N           344.284
E           125.891
Z           15.564
Cd [REDACTED]
Tgt.h       2.000m
[OK] [ADD] [LIST] [SRCH]
```

23.6 Recording Distance and Coordinate Data

Distance measurement data and coordinate data can be stored in the current JOB at the same time.

- Both distance measurement data and coordinate data are recorded as the same point number.
- Distance measurement data is recorded first, then coordinate data is recorded.

►PROCEDURE

- Press **[REC]** in the third page of Meas mode to display <REC>.

2. Select "Dist + Coord data" to display <REC/DIST + C>.

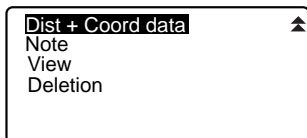

3. Sight the point and press **[OBS]** to begin the measurement.
The measurement results are displayed.

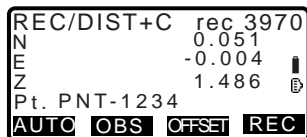

4. Press **[REC]** in the screen of step 3, and set the following items.
- (1) Code
 - (2) Target height
 - (3) Point number

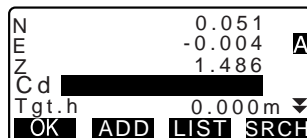

5. Check the input data, then press **[OK]**.
6. Press **{ESC}** to quit measurement and restore <REC>.

23.7 Recording Notes

This procedure prepares notes data and records it in the current JOB.

► PROCEDURE

1. Press **[REC]** in the third page of Meas mode to display <REC>. Select "Note".

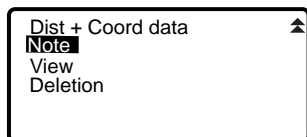

23. RECORDING DATA - RECORD MENU -

2. Enter the note data.

REC/Note	rec 2823
Tree 01 Left	
OK	A

3. After inputting the note data, press **[OK]** to return to <REC>.



- Maximum note length: 60 characters (alphanumeric)

23.8 Reviewing JOB Data

It is possible to display the data within the current JOB that is selected.

- It is possible to search for data within the JOB to be displayed by point number. But the note data cannot be searched.
- Known point data that are entered from an external instrument are not reviewed.

► PROCEDURE Reviewing JOB data

1. Press **[REC]** in the third page of Meas mode to display <REC>. Select "View" to display the list of recorded points.

```
Dist + Coord data ▲
Note
View
Deletion
```

2. Select the point number to be displayed in detail and press **[←]**. Details of the data are displayed. This screen contains distance measurement data.

```
St n 1
RED 2
Bkb 2
Ang. 2
Djst 3
↑↓...P TOP LAST SRCH ▼
```

```
S 123.456m
ZA 20°31'21"
HAR 117°32'21"
Cd 1010
Tgt.h 12.345m ▼
NEXT PREV EDIT RED
```

- To display previous data item, press **[PREV]**.
- To display next data, press **[NEXT]**.
- Press **[EDIT]** to edit code/target height/point number of the selected point number. Items that can be edited depend on the type of data selected. Press **[OK]** to confirm changes and return to the previous screen.
- **[↑↓...P]** = Use {▲}/{▼} to move from page to page.

23. RECORDING DATA - RECORD MENU -

- [**↑↓...P**] = Use {**▲**}/**{▼}** to select individual point.
- Press [**TOP**] to display first data.
- Press [**LAST**] to display last data.
- Press [**SRCH**] to search for point number. Input the point number after "Pt. No".
The search may take time if many data are registered.
- Press [**RED**] to display the reduced data screen shown at right.
Press [**OBS**] to return to the previous screen.

H	1234.456m	
V	-321.123m	
Azimuth	12°34'56"	
Cd	1010	
Tgt. h	12.345m ▼	
NEXT	PREV	OBS

3. Press {**ESC**} to conclude detailed display and restore the list of points.
Press {**ESC**} again to restore <REC>.

Note

- If more than two points with the same point name exist in the current JOB, SET finds the newer data only.

23.9 Deleting Recorded JOB Data

It is possible to delete data from the currently selected JOB.

► PROCEDURE Deleting Recorded JOB data

1. Press **[REC]** in the third page of Meas mode to display <REC>. Select "Deletion" to display the list of recorded points.

```
Dist + Coord data
Note
View
Deletion
```

2. Select the data item to be displayed in detail and press **[←]**. Details of the data are displayed.

```
Stn 1
RED 2
Bkb 2
Ang. 2
Djst 3
↑↓·P TOP LAST SRCH
```

```
S 123.456m
ZA 20°31'21"
HAR 117°32'21"
Cd 1010
Tgt .h 12.345m
NEXT PREV DEL
```

- To display previous data item, press **[PREV]**.
- To display next data, press **[NEXT]**.
- **[↑↓...P]** = Use {▲}/{▼} to move from page to page.
- **[↑↓...P]** = Use {▲}/{▼} to select individual point.
- Press **[TOP]** to display first data.
- Press **[LAST]** to display last data.
- Press **[SRCH]** to search for point number. Input the point number after "Pt. No".

The search may take time if many data are registered.

23. RECORDING DATA - RECORD MENU -

3. Press **[DEL]** to display the screen at right.

Press **[YES]** to delete and return to the second screen in step 1.

- Press **[NO]** to return to the second screen in step 1 without deleting.

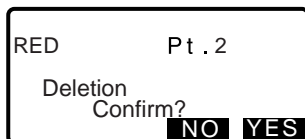

- Check data items before deleting to avoid losing important data.
- Deleting an important data item, such as instrument station coordinates, can prevent successful completion of software operations that require such data after outputting to an external device.

24. SELECTING/DELETING A JOB

24.1 Selecting a JOB

Select the current JOB and Coordinate Search JOB.

- A total of 10 JOBS have been prepared, and JOB1 was selected when your SET was shipped from the factory.
- The names of the JOBS have been preset as JOB1 to JOB10; you can change them to any names you wish.
- Scale factor can be set for each JOB. Only scale factor of the current JOB can be edited.



Current JOB

Measurement results, instrument station data, known points data, notes and coordinate data are recorded in the current JOB.

 Registering known point data: "25.1 Registering/Deleting Known Point Data".



Coordinate Search JOB

The registered coordinate data in the JOB selected here can be read into coordinate measurement, resection measurement, setting-out measurement, etc.



Scale correction

SET calculates horizontal distance and coordinates of a point using measured slope distance. If scale factor has been set, scale correction is carried out during calculation.

$$\text{Corrected horizontal distance (s)} = \text{Horizontal distance (S)} \times \text{Scale factor (S.F.)}$$

- When scale factor is set to "1.00000000", the horizontal distance is not corrected.

► PROCEDURE JOB selection and scale factor setting

1. Select "JOB" in Memory Mode.

Memory
JOB
Known data
Code
Dialup

24. SELECTING/DELETING A JOB

2. Select "JOB selection".
<JOB selection> is displayed.

```
JOB
JOB selection
JOB name edit
JOB deletion
Comms output
Comms setup
```

3. Press [LIST].

```
JOB selection
: JOB1
S.F.=1.00000000
Coord search JOB
: JOB
LIST S.F.
```

- JOB can also be selected by pressing **▶**/**◀**.
- The numbers to the right represent the number of data items in each JOB.
- "*" means that the JOB has not been output to an external device yet.

```
JOB selection
JOB01 46
*ATUG1 254
JOB03 0
JOB04 0
JOB05 0▼
```

4. Align the cursor with the desired JOB as the current JOB and press **←**.
- The JOB is determined.

5. Press [S.F].
Enter the scale factor for the current JOB.

```
JOB 1
S.F.=1.00000000
```

6. Press **←**.
- <JOB selection> is restored.
7. Align the cursor with "Coord search JOB" and press [LIST].
<Coord search JOB> is displayed.

- Align the cursor with the desired JOB as the coordinate search JOB and press {←}.
The JOB is determined and <JOB> is restored.

Note

- The list of JOB names is contained on up to 2 pages.
 - Scale factor input range : 0.50000000 to 2.00000000 (*1.00000000)
- “*” : Factory setting

►PROCEDURE Inputting a JOB name

- Select “JOB” in Memory mode.
- Select in advance the JOB whose name to be changed.
☞ “PROCEDURE JOB selection and scale factor setting”
- Select “JOB name edit” in <JOB>.
Input the new JOB name and press {←}.
<JOB> is restored.

```
JOB
JOB selection
JOB name edit
JOB deletion
Comms output
Comms setup
```

```
JOB name edit
JOB03
```

Note

- Maximum length of JOB name: 12 (alphanumeric)

24.2 Deleting a JOB

It is possible to clear the data within a designated JOB. After the data has been cleared, the JOB name returns to the name allocated when the SET was shipped.

Note

- A JOB that has not been output to an auxiliary device (displayed with *) cannot be deleted.

24. SELECTING/DELETING A JOB

►PROCEDURE

1. Select "JOB" in Memory Mode.
2. Select "JOB deletion".
<JOB deletion> is displayed.
 - The numbers to the right represent the number of data items in each JOB.

```
JOB
JOB selection
JOB name edit
JOB deletion
Comms output
Comms setup
```

```
JOB deletion
JOB01                46
*ATUGI                254
JOB03                0
JOB04                0
JOB05                0
```

3. Align the cursor with the desired JOB and press {←}.
4. Press [YES]. The data within the JOB selected is deleted and <JOB deletion> is restored.

```
JOB03
deletion
Confirm ?
NO YES
```

25. REGISTERING/DELETING DATA

25.1 Registering/Deleting Known Point Data

It is possible to register or delete coordinate data of the known points in the current JOB.

The coordinate data that has been registered can be output during setting for use as instrument station, backsight station, known point, and setting-out point coordinate data.

- It is possible to register 10000 items of coordinate data, including the data inside the JOBS.
- There are two registration methods: key entry and entry from an external instrument.
 - ☞ Communication cables: "35. OPTIONAL ACCESSORIES"
Output format and command operations: "Interfacing with the SOKKIA SDR Electronic Field Book" and "Command Explanations" manuals.
- When entering known point data from an external device, SET does not check the repeated point number.
- Communication setup can be performed in the known data as well. Select "Comms Setup" in <Known data>.



- When "inch" is selected as the distance unit, the value must be input in "feet" or "US feet".

► PROCEDURE Using the key entry method to register known point coordinate data

1. Select "Known data" in Memory Mode.
 - Current JOB name is displayed.
2. Select "Key in coord" and input known point coordinates and point number.

```
Memory
JOB
Known data
Code
```

```
Known data
Job.JOB1
Key in coord
Comms input
Deletion
View
```

```
rec 3991
N 567.950
E -200.820
Z 305.740
Pt. 5
```

25. REGISTERING/DELETING DATA

- After setting the data, press **{←}**.
The coordinate data is recorded in the current JOB and screen in step 2 is restored.
- Continue to enter other known point coordinate data.
- After the registration of all the coordinate data has been completed, press **{ESC}** to restore <Known data>.

```
rec 2641
N 567.950
E -200.820
Z 305.740
Pt. 5
Recorded
```

►PROCEDURE Entering known point coordinate data from an external instrument

- Connect SET and host computer.
- Select "Known data" in Memory Mode.
 - Current JOB name is displayed.
- Select "Comms input" to display <Comms input>.
Coordinate data starts to be entered from an external instrument and the number of received items is displayed on the screen. When data reception is completed, <Known data> is displayed.
 - Press **{ESC}** to stop data reception in progress.

```
Known data
Job..JOB1
Key in coord
Comms input
Deletion
View
```

```
Comms input
Format SDR33
Receiving 12
```

►PROCEDURE Deleting designated coordinate data

1. Select "Known data" in Memory Mode.
2. Select "Deletion" to display the list of known point data.

```
Known data
Job.JOB1
Key in coord
Comms input
Deletion
View
```

```
Pt. 0
Pt. 1
Pt. 12345678
Pt. 12345679
Pt. SOKKIA
1..P TOP LAST SRCH
```

3. Select the point number to be deleted and press {←}.
 - [↑↓...P] = Use {▲}/{▼} to move from page to page.
 - [↑↓...P] = Use {▲}/{▼} to select individual point.
 - Press [TOP] to display top of point number list.
 - Press [LAST] to display end of point number list.
 - Press [SRCH] to search for point number. Input the point number after "Pt. No."

```
N 567.950
E -200.820
Z 305.740
Pt. 5
NEXT PREV DEL
```

The search may take time if many data are registered.

4. Press [DEL] to delete the selected point number.
 - Press [PREV] to display previous data.
 - Press [NEXT] to display next data.
5. Press {ESC} to quit the point number list and return to <Known data>.

```
Pt. no. A
:
```

25. REGISTERING/DELETING DATA

►PROCEDURE Clearing all coordinate data at once (initialization)

1. Select "Known data" in Memory Mode.
2. Select "Clear" and press {←}.

```
Known data
Job.JOB1
Clear
Comms setup
```

3. Press [YES].
<Known data> is restored.

```
Clear
Confirm ?
NO YES
```

25.2 Reviewing Known Point Data

It is possible to display all the coordinate data within the current JOB.

►PROCEDURE

1. Select "Known data" in Memory Mode.
 - Current JOB name is displayed.

2. Select "View".
The point number list is displayed.

```
Known data
Job.JOB1
Key in coord
Comms input
Deletion
View
```

3. Select the point number to be displayed and press {←}.
The coordinates of the selected point number are displayed.

```
Pt. 0
Pt. 1
Pt. 12345678
Pt. 12345679
Pt. SOKKIA
P TOP LAST SRCH
```

```
N 567.950
E -200.820
Z 305.740
Pt. 5
NEXT PREV DEL
```

- Press **{ESC}** to restore the point number list.
Press **{ESC}** again to restore <Known data>.

25.3 Registering/Deleting Codes

It is possible to save codes in memory. You can also read in codes registered in memory when recording instrument station data or observation data.

►PROCEDURE Inputting Codes

- Select "Code" in Memory Mode.

```
Memory
JOB
Known data
Code
Dialup
```

- Select "Key in code".
Enter the code and press **{←}**.
The code is registered and <Code> is restored.

```
Code
Key in coord
Deletion
Code view
Clear list
```

Note

- Maximum code size: 16 (alphanumeric)
- Maximum number of codes registered: 60

```
Code
: Pole
```

►PROCEDURE Deleting codes

- Select "Code" in Memory Mode.

25. REGISTERING/DELETING DATA

2. Select "Deletion". The registered code list is displayed.

```
Code
Key in coord
Deletion
Code view
Clear list
```

3. Align the cursor with the code to be deleted and press **[DEL]**.
The designated code is deleted.

```
Pole
A001
TREE01 LEFT
POINT01
POINT02
↑↓·P TOP LAST DEL
```

4. Press **{ESC}** to restore <Code>.



- If you select "Clear list" in step 2 and then press **[YES]**, all registered codes are deleted.

25.4 Reviewing Codes

► PROCEDURE

1. Select "Code" in Memory Mode.
2. Select "Code view".
The registered code list is displayed.

```
Code
Key in coord
Deletion
Code view
Clear list
```

3. Press **{ESC}** to restore <Code>.

```
Pole
A001
Point 001
TREE01 LEFT
POINT01
↑↓·P TOP LAST
```

26. OUTPUTTING JOB DATA

It is possible to output JOB data to a host computer or printer.

 Communication cables: "31.6 Optical Plummet"

Output format and command operations: "Interfacing with the SOKKIA SDR Electronic Field Book" and "Command Explanations" manuals.

- Measurement results, instrument station data, known point data, notes, and coordinate data in the JOB is output.
- Known point data entered from an external instrument is not output.
- Communication setup can be performed in the JOB menu as well. Select "Comms Setup" in <JOB>.



- When "inch" is selected as the distance unit, data is output in "feet" or "US feet" depending on the feet unit selected.

► PROCEDURE Outputting JOB data to host computer

1. Connect SET and host computer.

2. Select "JOB" in Memory Mode.

```
Memory
JOB
Known data
Code
```

3. Select "Comms output" to display the JOB list.

```
JOB
JOB selection
JOB name edit
JOB deletion
Comms output
Comms setup
```

4. Select the JOB to be output and press {}.
"Out" appears to the right of the JOB selected. You can select as many JOBS as you want.

```
*JOB01      Out
ATUGI      254
JOB03     Out
JOB04      0
JOB05      0
OK
```

- "*" means the JOB has not been output to an external device yet.

5. Press [OK].

26. OUTPUTTING JOB DATA

6. Select the output format and press {←}.

```
Comms output
SDR33
SDR2X
Printed output
```

7. Select the output data and press {←}.

Output starts. When the output is complete, the JOB list is restored. It is possible to continue output of the next JOB.



- Select "Obs data" to output distance measurement data.
- Select "Reduced data" to output distance measurement data and reduced data.
- To stop output, press {ESC}.

```
Comms output
Obs data
Reduced data
```

►PROCEDURE Outputting JOB data to printer

1. Select "JOB" in Memory Mode.
2. Select "Comms output" to display the JOB list.

```
JOB
JOB selection
JOB name edit
JOB deletion
Comms output
Comms setup
```

3. Select the JOB to be output and press {←}.

"Out" appears to the right of the JOB selected. You can select as many JOBS as you want.
4. Press [OK].
5. Connect SET and printer.
6. Turn ON the printer.
7. Select "Printed output" and press {←}.

8. Select the output data and press **{←}**.

Output starts. When the output is complete, the JOB list is restored. It is possible to continue output of the next JOB.

- Select "Obs data" to output distance measurement data.
- Select "Reduced data" to output distance measurement data and reduced data.
- To stop output, press **{ESC}**.

27. TRANSFERRING DATA WITH SFX FUNCTION

The SFX Dial-up program allows the operator to connect the Total Station to a cellular phone in order to exchange data by connecting to an FTP server or to transfer data as email attachments between the surveying instrument and a computer, while in the field. Coordinate data transferred to the Total Station in this way can be added into JOB data.

All data needed for surveying can be exchanged at the worksite.

Ex. 1

As data can be sent to a computer via e-mail, there is no need to return to the office to hand over surveyed data.

Ex. 2

All data needed for surveying can be transferred via e-mail so there is no need to waste time downloading before heading for the worksite.

Ex. 3

Surveyed data can be sent promptly back to the office for processing allowing the operator to get feedback on the quality of the surveyed data quickly and without having to leave the worksite. The operator can respond to deficiencies in the data much faster as a result.

Ex. 4

Coordinate data can be exchanged between Total Stations using the SFX function allowing greater flexibility when allocating tasks in the field.

- A program designed to allow Internet provider information, e-mail address, and FTP server information to be set on an operator's PC is available free of charge. For details, ask your local dealer.

27.1 Necessary items

The following items are necessary in order to use the SFX dial-up program with the SET.

- Cellular phone with built-in modem
- Interface cable
Dedicated optional accessory for connecting the SET and your cellular phone.
- Internet provider service
An Internet provider service is necessary in order to be able to send and receive e-mail. The access details supplied by your provider are input when configuring the e-mail settings on the SET.



Sokkia Topcon Co., Ltd. cannot guarantee that all cellular phones with built-in modems are compatible with the SFX system. Therefore, to check the compatibility of your cellular phone, please consult your local dealer.

27.2 Connecting all equipment

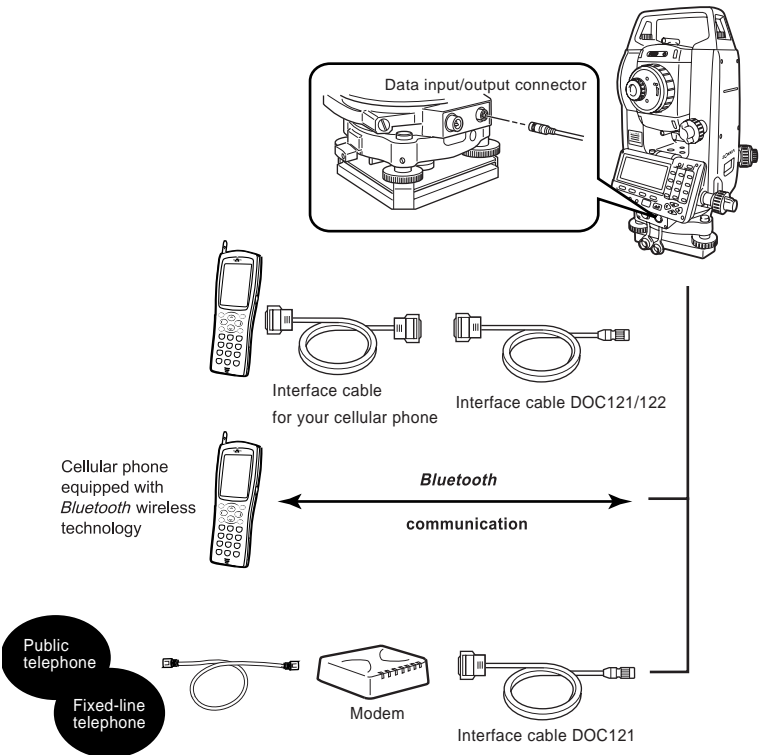

Connect all equipment as shown below. Make sure that the power of both the SET and the cellular phone is off before connecting.

 For connecting the cellular phone to the dedicated interface cable, see the operator's manual for your cellular phone/interface cable.



27. TRANSFERRING DATA WITH SFX FUNCTION

- DOC121 is for the NOKIA DLR-3P interface cable (accessory for phones such as the NOKIA 6310iw).
- DOC122 is for the Motorola SKN6315A interface cable and SYN0279B adapter (accessory for phones such as the Motorola V66).

 For communication between the SET and the cellular phone using *Bluetooth* technology (no interface cables necessary), see "28.2 Configuration - Config Mode-  SFX Communication using *Bluetooth* technology"

27.3 Booting up and quitting SFX

► PROCEDURE Booting up

1. Select "Dial-up" from the Memory mode screen.

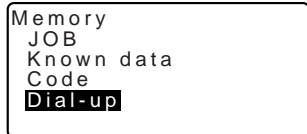

2. Input the previously registered password and press .

As no password was set at the factory, leave blank and press .

Press **{ESC}** to return to Memory mode.

 Setting/changing passwords: "27.4 Setting a password"

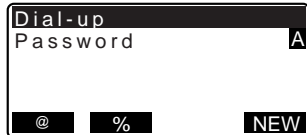

The power cannot be turned off in screens after setting a password in the SFX program.

► PROCEDURE Quitting

1. Press **{ESC}** repeatedly to return to Memory Mode. The power can now be turned off.

27.4 Setting a password

Internet provider details and the operator's e-mail address are recorded in the SFX Dial-up program. Setting a password is recommended to improve the security of this information.

► PROCEDURE

1. Press **[NEW]** in <Dial-up>.

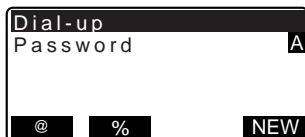

2. Input the current password and press **{←}**.

No password was set at the factory. Leave blank and press **{←}**.

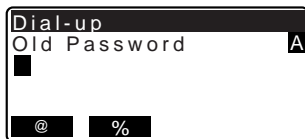

3. Input the new password and press **{←}**. The new password is now set. <Dial-up> will be displayed.

The maximum password length is 32 alphanumeric characters.

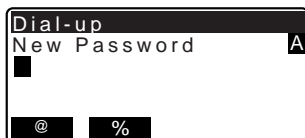

Note

- When a password is forgotten, clear the memory to return the password to the factory setting. JOB data and communication settings will be lost when the memory is cleared.

 "28.5 Restoring Default Settings"

27.5 Registering Internet provider information

Internet provider information must be registered on the SET in order to use the e-mail function.

► PROCEDURE

1. After inputting the password, press **[ISP]** to display the Internet provider settings.

```
Dial-up
Send mail
Receive mail
FTP connect

ADR  FTP  ISP  MODEM
```

```
Setup ISP
Phone1:0066-22-252
Phone2:03-4360-260
Phone3:0,,0066-22
PPP login: abc00099
```

```
Setup ISP
PPP password: *****
Mail address: sokki
POP server: pop.sok
POP login: user1_so
```

```
Setup ISP
POP password:*****
Leave on server: Y
SMTP server: smtp.s
SMTP auth: N
```

```
Setup ISP
IP address: 0.0.0.0
DNS1: 202.203.204.2
DNS2: 202.203.204.2
Timeout(sec): 90
```

2. Use { **▲** } / { **▼** } to highlight the setting to be modified and press { **←** }. When the respective screen is displayed input the new details and press { **←** }.
3. Press **[ESC]** to finish settings and return to <Dial-up>.



- The following settings are made by the operator. The information marked with * is supplied by your Internet provider. For any inquiries regarding this information, ask your Internet provider.

Phone*

Input the telephone number (including area code) for the access point. Use no more than 64 characters. Spaces and hyphens may be omitted. Up to 3 telephone numbers may be registered.

PPP login*

Input the PPP connection login name.

PPP password*

Input the PPP connection password.

Mail address*

Input the e-mail address allocated to that instrument. The maximum address length is 64 characters.

POP server*

Input the POP server name using no more than 64 characters.

POP login*

Input the login name for the POP server using no more than 64 characters.

POP password*

Input the POP server password using no more than 64 characters.

SMTP server*

Input the POP server name using no more than 64 characters.

SMTP auth*

If your Internet provider uses "POP-before-SMTP" (a method of user authentication used when sending e-mail) select "Y". Otherwise select "N".

IP address*

Input the IP address when allocated. When using an address automatically assigned by the server input "0.0.0.0".

27. TRANSFERRING DATA WITH SFX FUNCTION

DNS1, DNS2*

Input the primary (DNS1) and secondary (DNS2) addresses for the DNS server. When no DNS server is used input "0.0.0.0".

Timeout

Set the timeout, in seconds, for the connection to the server.

Leave on server

To leave received e-mail on the server, select "Y". To delete received e-mail, select "N".

27.6 Registering FTP server information

FTP server information must be registered on the SET in order to use the FTP server connection function. Up to 3 servers can be registered.

►PROCEDURE

1. After inputting the password, press **[FTP]** to display the Internet provider settings.
2. Use { ▲ }/{ ▼ } to highlight the setting to be modified and press { ← }.



```
Select FTP server
SOKKIA_HOME
my_private
survey_office
```

When the respective screen is displayed, input the new details and press **{←}**.

```
Setup FTP server
Name: SOKKIA_HOME
Phone: 0,,,090-4936
PPP login: user01
PPP password: *****
```

```
Setup FTP server
IP address: 192.168
DNS1: 0.0.0.0
DNS2: 0.0.0.0
FTP server: 192.168
```

```
Setup FTP server
FTP login: user1
FTP password: *****
Timeout(sec): 90
```

3. Press **{ESC}** to finish settings and return to the screen shown in step 1.



- The following settings are made by the operator. Obtain information marked with * from your system administrator.

Name*

Input the server name using no more than 32 characters.

Phone*

Input the telephone number (including area code) for the access point. Use no more than 64 characters. Spaces and hyphens may be omitted. Up to 3 telephone numbers may be registered.

PPP login*

Input the login name for PPP connection.

PPP password*

Input the password for PPP connection using no more than 32 characters.

IP address*

Input IP address. When using the DHCP protocol, input "0.0.0.0".

27. TRANSFERRING DATA WITH SFX FUNCTION

DNS1/DNS2 address*

Input the DNS1/DNS2 address. When no DNS server is used input "0.0.0.0."

FTP server address*

Input "aaa@bbb.co.jp" as the FTP server address.

FTP login*

Input the login name for the FTP server using no more than 64 characters.

FTP password*

Input the login name for the FTP server using no more than 32 characters.

Timeout

Set the timeout, in seconds, for the connection to the server.

27.7 Registering an e-mail address

Register the outgoing e-mail address (no more than 64 characters) beforehand. Up to 5 e-mail addresses can be registered.

►PROCEDURE

1. After inputting the password, press **[ADR]** to display the currently registered e-mail addresses. Use { **▲** }/ { **▼** } to highlight the desired e-mail address.
2. Input the e-mail address and press { **←** }.
3. Press { **ESC** } to finish settings and return to the screen shown in step 1.

```
Dial-up
Send mail
Receive mail
FTP connect
ADR  FTP  ISP  MODEM
```

```
Setup mail address
user1@sokkia.com
set2030_01@survey.c
smith@sokkia.com
abc001@efghijklmn
-----
```

```
Setup mail address
user1@sokkia.com
@  %
```

**Saving settings**

- All settings are saved when the operator quits the program. SFX will function according to these new and modified settings once the program has been shut down then rebooted.

27.8 Sending e-mail (JOB data)

JOB data can be sent from the SET as e-mail attachments.

Rules for sending e-mail: "27.11 Sending e-mail to the SET"

► PROCEDURE

1. After inputting the password select "Send mail".
2. Select a telephone number. "connecting..." is displayed on the SET.

When a connection has been established <Send mail (Online)> is displayed on the SET.

```
Select Phone Number
0066-22-2525
03-4360-2600
0...0066-22-2525
```

3. Use {▲}/{▼} to highlight the JOB to be sent and press {←}. "OUT" is displayed. Press {←} again to remove "OUT". Once all the JOBS to be sent have been selected, press [OK].

```
Send Mail(Online)
JOB1                OUT
JOB2                OUT
JOB3                442
JOB4                576
OFF                 OK
```

4. Select the destination e-mail address and press {←}. "OUT" is displayed. Multiple destination addresses can be selected. Once all destination addresses have been selected, press [OK].

```
Send Mail(Online)
user1@sokkia.co    OUT
set2030_01@surv   OUT
smith@sokkia.co
abc001@efghijkl
OFF                 OK
```

27. TRANSFERRING DATA WITH SFX FUNCTION

5. Transmission starts.

The name of the JOB currently being transmitted and the number of records (JOB data records) successfully transmitted are displayed on the screen during transmission.

```
Send Mail(Online)
Sending...
63
JOB01
Wait for moment
OFF
```

- JOBS are sent one JOB per e-mail.

When all selected JOBS have been successfully transmitted, SFX disconnects from the internet and returns to <Dial-up>.



Pressing **[OFF]** during transmission will forcibly cut the connection and stop transmission. The transmission of the current JOB may not be successfully completed as a result.

27.9 Receiving e-mail with the SET (coordinate data)

After reading in a coordinate file sent as an e-mail attachment in SDR format, the SET records it as coordinate data at the end of the currently selected JOB.

 Rules for receiving e-mail: "27.12 Receiving e-mail from the SET"

► PROCEDURE

1. After inputting the password, select "receive mail".

"PPP connecting..." is displayed on the SET.

```
Dial-up
Send mail
Receive mail
FTP connect
ADR  FTP  ISP  MODEM
```

When a connection has been established <Receive Mail (Online)> is displayed.

```
Receive Mail(Online)
Receive mail.st...
  2/3

Wait for moment
OFF
```

2. SFX will automatically search the server for all e-mail for the SET. A list of all SET-related incoming e-mail and the respective data type will be displayed.

```
Receive Mail(Online)
SDR>test
SDR>P14
SDR>JOB1

OFF OK
```

3. Select an e-mail to read and press **[OK]**. While receiving the coordinate data attached to the selected e-mail, the file name and number of coordinate points in the current file are displayed.

```
Receive Mail(Online)
Receiving...
78
SDR>test
Wait for moment
OFF
```

When read-in is complete, SFX disconnects from the internet and returns to <Dial-up>.



Pressing **[OFF]** during transmission will forcibly cut the connection and stop transmission. All the data currently being received will be lost.

27.10 FTP server connection (coordinate data/JOB data)

The SET accesses an office or PC FTP server in order to write or read in JOB data or coordinate data.



- The file to be sent is converted to SDR format and written to the server as "Job No.sdr".
- When a file with the same name already exists on the server, a letter (from a to z) is appended to the end of the most recent file name (JOB name).

27. TRANSFERRING DATA WITH SFX FUNCTION

- The SET can only read in files with the file extension ".sdr".
- From the files with the extension ".sdr", only coordinate data is read in. The SET records it as coordinate data at the end of the currently selected JOB.

►PROCEDURE Writing (sending) a file

1. After inputting the password,
select "FTP connect".

```
Dial-up
Send mail
Receive mail
FTP connect
ADR  FTP  ISP  MODEM
```

2. Select the relevant server in
<Select FTP server> and press
{←}.

"PPP connecting..." is displayed
on the SET.

```
Select FTP server
SOKKIA_HOME
my_private
survey_office
```

When a connection has been
established <FTP server (Online)>
is displayed.

3. Select "Send SDR Job" and press
{←}.

```
FTP server(Online)
Send SDR Job
Receive file
OFF
```

4. Use {▲}/{▼} to highlight the JOB
to be sent and press {←}.
"OUT" is displayed. Press {←}
again to remove "OUT". Once all
the JOBS to be sent have been
selected press [OK].

```
FTP Server(Online)
JOB1      OUT
JOB2      OUT
JOB3      442
JOB4      576
OFF      OK
```

Transmission starts.

The name of the JOB currently
being transmitted and the number
of records (JOB data records,
coordinate points) successfully
transmitted are displayed on the
screen during transmission.

When all selected JOBs have been successfully transmitted, SFX disconnects from the internet and returns to <Dial-up>.



Pressing **[OFF]** during transmission will forcibly cut the connection and stop transmission. The transmission of the current JOB may not be successfully completed as a result.

►PROCEDURE Reading in (receiving) a file

1. After inputting the password, select "FTP connect".
2. Select the relevant FTP server in <Select FTP server> and press {←}.
"PPP connecting..." is displayed on the SET.

When a connection has been established <FTP server (Online)> is displayed.

3. Select "Receive file" and press {←}.

SFX will automatically search the server for all data for the SET. A list of all SET-related data and the respective data type will be displayed.



27. TRANSFERRING DATA WITH SFX FUNCTION

4. Select the file containing the desired coordinate data and press {←}.
{←}.

```
FTP server(Online)
.. <DIR>
SDR>FACTORY_SYTE
SDR>JOB1
SDR>JOB1a
OFF
```

While receiving the file, the file name and number of coordinate points in the current file are displayed.

When read-in is complete, SFX disconnects from the internet and returns to the <Dial-up>.



Pressing **[OFF]** during transmission will forcibly cut the connection and stop transmission. All the data currently being received will be lost.

27.11 Sending e-mail to the SET

E-mail is sent from the computer to the SET using standard e-mail programs.

The method for sending an e-mail from the computer to the SET is the same as that for sending a normal e-mail.

Compose an e-mail addressed to the address assigned to the SET.



- So that the SET can distinguish which e-mails to receive, input "SDR>" followed by a user-specified title in the subject line.
- SDR-format coordinate data appended as an attachment. The file extension for attachment files should be ".sdr".
- Text input in the body of the message will not be displayed on the SET.
- Even if multiple files are attached to a single e-mail, the SET can only receive the first attachment.

Microsoft Outlook Express 6.0 Example

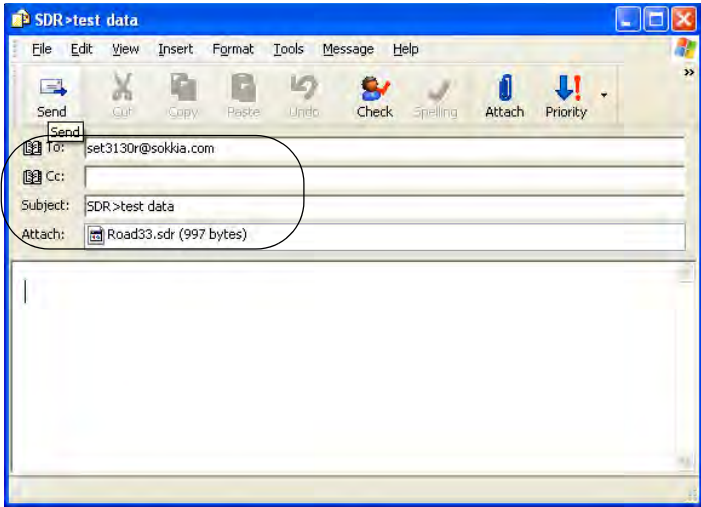

The SET selects incoming e-mail with a subject line starting with "SDR>" and displays them in a list.

 For more details on sending and receiving e-mails, see the operator's manual for your e-mail program.

27.12 Receiving e-mail from the SET

The method for receiving an e-mail from the SET on a computer is the same as that for receiving a normal e-mail.



- The subject line of the e-mail sent from the SET will be in the format, "SDR->JOBNo." and the file name of the attached e-mail in the format, "JOB name.sdr".

Microsoft Outlook Express 6 Example

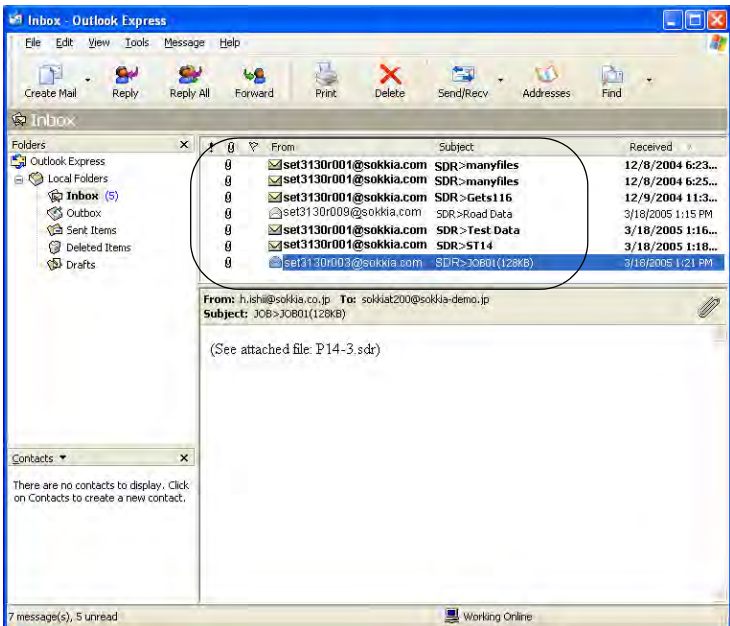

For more details on sending and receiving e-mails, see the operator's manual for your e-mail program.

27.13 Troubleshooting

What follows is a list of foreseeable problems the operator may encounter while using SFX. Under each heading is a description of items to check and possible solutions. When a problem not listed here occurs or the suggested solution is ineffective, contact your local dealer.

Forgotten password

Clear the memory, delete password settings and set a new password.

Clearing the memory will delete all data.

Any important data should be transferred to a computer beforehand.

Loss of power during communication

A depleted battery cannot be replaced during communication. Check the remaining battery power before starting communication.

If the battery power is completely depleted during communication, the instrument will switch off but will still be connected to the internet. Disconnect the Internet connection before replacing the battery.

It is possible that e-mail has not been successfully transferred. If necessary transfer the e-mail again.

Failed connection

Cellular phone reception

Whenever possible, perform communication in areas where there is good cellular phone reception. When performing communication indoors radio field intensity is weak and the connection is unstable. For the service area of your cellular phone, ask your telecoms operator. For other details, see the operator's manual for your cellular phone.

E-mail program settings

Certain e-mail program settings may result in communication failure.

Please consult the settings screen shown below. If the "No Attachment" error message is displayed even when a file has been attached, type a message in the body section of the e-mail.

27. TRANSFERRING DATA WITH SFX FUNCTION

- (1) Using Microsoft Outlook Express 6
Select [Tools] - [Options] to open the following window.

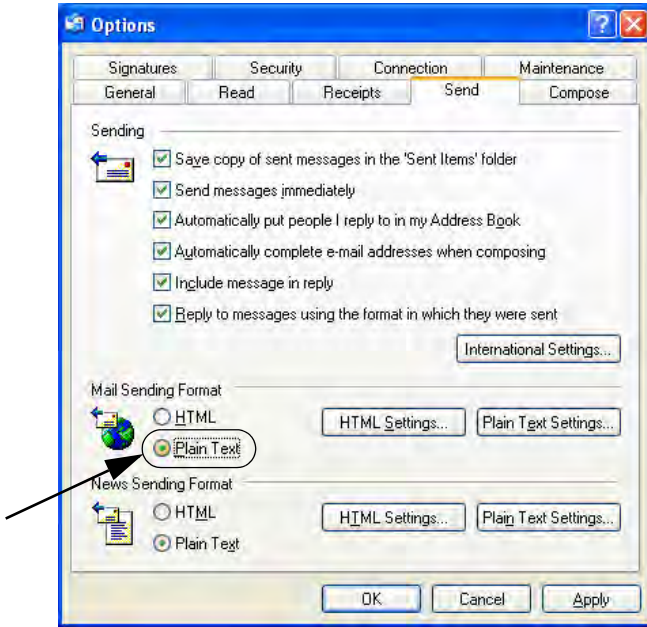

Set "Mail Sending Format" in the [Send] tab to "Plain Text".

Press "Plain Text Settings" to open the next window.

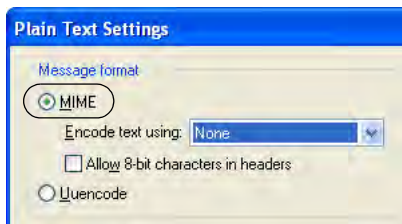

Set "message format" to "MIME".

- (2) When using Mozilla 1.7.5
 Select [Format]-[Plain Text Only] from [Options].

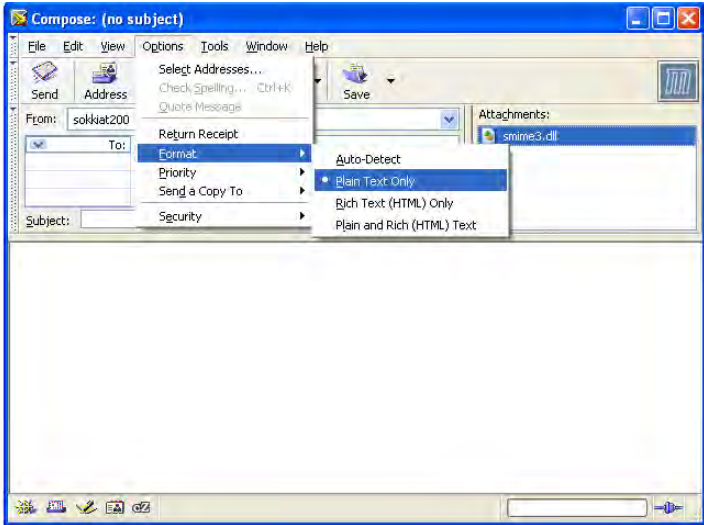

When an error occurs, the following error message appears.

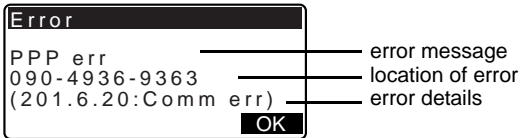

👉 For error messages and troubleshooting solutions, see "30. WARNING AND ERROR MESSAGES"

28. CHANGING THE SETTINGS

This section explains the contents of parameter settings, how to change settings and how to perform initialization. Each item can be changed to meet your measurement requirements.

28.1 EDM Settings

The following explains the EDM settings.

- "****": Factory setting

Press **[EDM]** in the second page of Meas mode.

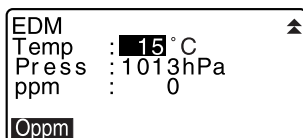
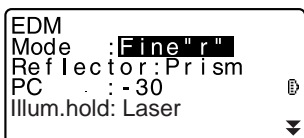

- **[0ppm]**: Atmospheric correction factor returns to 0 and temperature and air pressure are set to the default values.
- Atmospheric correction factor is calculated and set using the entered values of the temperature and air pressure. Atmospheric correction factor can also be entered directly.



- "Illum. hold" is displayed only when the guide light option is mounted.

Items set, options, and input range (*: Factory setting)

Mode (Distance measurement Mode)	Fine "r"*, Fine AVG (Setting: 1 to 9 times), Fine "s", Rapid "s", Tracking
Reflector	Prism*, Sheet, None (reflectorless)
PC (Prism constant)	-99 to 99 mm ("Prism" is selected: -30*, "Sheet" is selected: 0*)
Illum. hold	Laser (laser sight)*, Guide (Guide light)
Temp. (Temperature)	-30 to 60°C (15*)
Air pressure	500 to 1400hPa (1013*)/ 375 to 1050mmHg (760*)
ppm (Atmospheric correction factor)	-499 to 499 (0*)



- The screen will be displayed only when "Illum. hold" is set to "Guide" and the cursor is on "Guide".

Item set and option (*: Factory setting)

The Guide light (Brightness level of the guide light)	1 to 3 (*)
---	------------



Atmospheric correction factor

The SET measures the distance with a beam of light, but the velocity of this light varies according to the index of refraction of light in the atmosphere. This index of refraction varies according to the temperature and air pressure.

- To precisely determine the atmospheric correction factor, the average temperature and air pressure along the measurement beam route must be taken. Take care when calculating the correction factor in mountainous terrain as the difference in height will result in differences in atmospheric conditions between two points.
- The SET is designed so that the correction factor is 0 ppm at an air pressure of 1013 hPa, a temperature of 15°C and a humidity of 0%.
- By inputting the temperature and air pressure values, the atmospheric correction value is calculated using the following formula and set into the memory.

$$\text{ppm} = 282.59 - \frac{0.2942 \times \text{air pressure (hPa)}}{1 + 0.003661 \times \text{air temperature (°C)}}$$

- If the weather correction is not required, set the ppm value to 0.
- The atmospheric correction factor can also be calculated in order to take humidity into account.

 "37.2 Atmospheric Correction for High Precision Distance Measurement"

28. CHANGING THE SETTINGS



Prism constant correction

Reflective prisms each have their prism constant.

Set the prism constant correction value of the reflective prism you are using. When selecting "None (Reflectorless)" in "Reflector", prism constant correction value is set to "0" automatically.

- The following are samples of the prism constant correction values of SOKKIA reflective prisms.

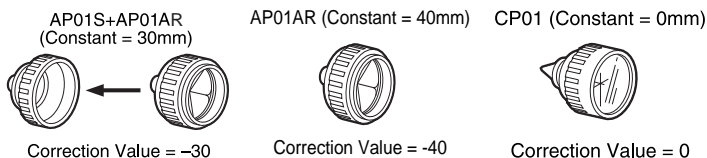

28.2 Configuration -Config Mode-

The following explains the Config Mode.

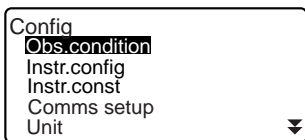

● Observation Condition

Select "Obs. condition" in Config mode

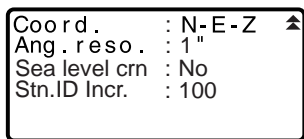
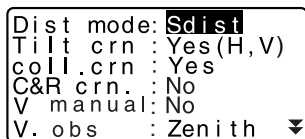

Items set and options (*: Factory setting)

Dist mode	Sdist*, Hdist, Vdist
Tilt crn (Tilt angle compensation)	Yes(H,V)*, Yes(V), No
coll. crn (Collimation correction)	Yes*, No

C&R crn. (Earth curvature and refraction correction)	No*, K=0.142, K=0.20
V manual	Yes, No*
V.obs (Vertical angle display method)	Zenith*, Horiz, Horiz 90° (Horizontal ±90°)
Coord.	N-E-Z*, E-N-Z
Ang.reso.(Angle resolution)	SET230RK/330RK/530RK:1"*, 5" SET630RK:1", 5"*
Sea level crn (Sea level correction)	Yes, No*
Stn.ID Incr. (station ID increment)	0 to 99999 (100*)



Automatic tilt angle compensation mechanism

The vertical and horizontal angles are automatically compensated for small tilt errors using the 2-axis tilt sensor.

- Read the automatically compensated angles when the display has stabilized.
- The horizontal angle error (vertical axis error) fluctuates according to the vertical axis, so when the instrument is not completely leveled, changing the vertical angle by rotating the telescope will cause the displayed horizontal angle value to change.
Compensated horizontal angle = Measured horizontal angle + Tilt in angle /tan (Vertical angle)
- When the telescope is directed close to the zenith or nadir angle, tilt compensation is not applied to the horizontal angle.



Collimation correction

The SET has a collimation correction function that automatically corrects horizontal angle errors caused by horizontal axis and leveling axis errors.



Sea level correction

The SET calculates horizontal distance using slope distance values. As this horizontal distance does not take height above sea level into consideration, performing spherical correction is recommended when measuring at high altitudes. Spherical distance is calculated as follows.

28. CHANGING THE SETTINGS

Spherical distance

$$= \frac{R - H_a}{R} \times d_1$$

Where:

R = radius of the spheroid (6372000.000m)

H_a = averaged elevation of the instrument point and target point

d₁ = horizontal distance



V obs. (vertical angle display method)

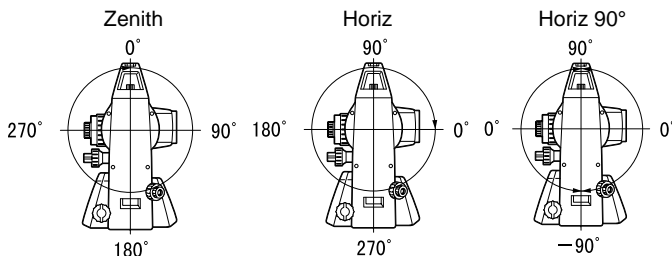

● Instrument Configuration

Select "Instr. Config" in Config mode

Power off	: 30min
Reticle lev	: 3
Contrast	: 10
Resume	: Of f
EDM ALC	: Free
Guide pattern	: 1



- "Guide pattern" is displayed only when the guide light option is selected.

Items set and options (*: Factory setting)

Power off	5min, 10min, 15min, 30min*, No
Reticle lev	0 to 5 level (3*)
Contrast	0 to 15 level (10*)
Resume	On, Off*
EDM ALC	Hold, Free*
Guide pattern	1 (the red and green lights flash simultaneously)* / 2 (the red and green lights flash alternately)

**Power-saving automatic cut-off**

To save power, power to the SET is automatically cut off if it is not operated for the selected time.

**Resume function**

When the Resume function is set to "On" and the power is switched off and then on again, the screen appearing before the instrument was switched off is redisplayed. When performing missing line measurement however, the screen display will return to the "MENU" screen (when measurement was initiated using the menu item) or the "Meas Mode" screen (when measurement was initiated using a softkey).

All parameter settings are also saved. Memory backup period is about one week, after which the Resume function is cancelled.

**EDM ALC**

Set the light receiving status of the EDM. While carrying out continuous measurement, set this item according to the measurement conditions.

- When EDM ALC is set to "Free" the instrument's ALC will be automatically adjusted if an error occurs as a result of the amount of light received. Set to "Free" when the target is moved during measurement or different targets are used.
- When "Hold" is set, the amount of light received will not be adjusted until initial adjustment has been performed and continuous measurement completed.
- Try setting to "Hold" when the light beam used for measurement is stable but is frequently obstructed by obstacles such as people, cars, or tree branches etc. preventing measurement from being performed.

**Note**

- The EDM ALC setting will automatically be switched to "Free" when the distance measurement mode is set to "Tracking" (target is moved during distance measurement).

● Communication Setup

Select "Comms setup" in Config mode

```
Wireless : No
Baud rate: 1200bps
Data bits: 8bit
Parity : Not set
Stop bit : 1bit
Check sum: No
```

```
Xon/Xoff : Yes
```

28. CHANGING THE SETTINGS

Items set and options (*: Factory setting)

Wireless	Yes, No*
Baud rate	1200bps*, 2400bps, 4800bps, 9600bps, 19200bps, 38400bps
Data bits	8bit*, 7bit
Parity	Not set*, Odd, Even
Stop bit	1bit*, 2bit
Check sum	Yes, No*
Xon/Xoff	Yes*, No

 Output format and command operations: "Interfacing with the SOKKIA SDR Electronic Field Book" and "Command Operations" manuals.

Note SFX Communication using *Bluetooth* technology

Data can also be transferred using *Bluetooth* technology when a cellular phone equipped with *Bluetooth* wireless technology is registered as a companion device.

( "29. WIRELESS COMMUNICATION USING BLUETOOTH TECHNOLOGY" PROCEDURE Registering Bluetooth companion devices")

Press [**MODEM**] in the screen at right.

Use {▶}/{◀} to select the cellular phone registered in the Link device list and press {←}.

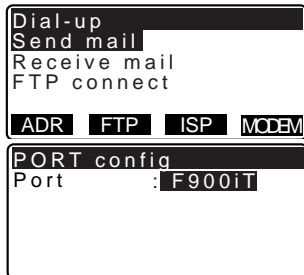

- To perform SFX communication using *Bluetooth* technology, "Wireless" in "Comms setup" must be set to "Yes".
- When "Wireless" is set to "No", the [**MODEM**] softkey will not be displayed in <Dial-up>. "Port" will be automatically set to COM PORT and cannot be changed.

● Unit

Select "Unit" in Config mode

Temp.	: 
Press.	: hPa
Angle	: degree
Dist	: meter

Items set and options (*: Factory setting)

Temp. (Temperature)	°C*, °F	
Press	hPa*, mmHg, inchHg	
Angle	degree*, gon, mil	
Dist	meter*, feet, inch	
Feet (only displayed when "feet" or "inch" selected above)	Int. feet* (1m = 3.280839895),	
	US feet	(1m = 3.280833333)



Inch (Fraction of an inch)

"Fraction of an inch" is the unit used in the United States and expressed like the following example.

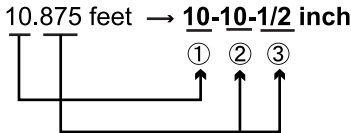

- ① 10.000 feet
- ② 0.875 feet x 12=10.5 inch
- ③ 0.5 inch=1/2 inch



- Even if "inch" is selected in this setting, all the data including the result of area calculation are output in "feet" and all the distance values must be input in "feet". In addition, when the "inch" display exceeds the range, it is displayed in "feet".



International feet and US survey feet

The SET can display feet values in International feet and US survey feet units.

28. CHANGING THE SETTINGS

International feet, the standard feet units, are referred to simply as “feet” elsewhere in this manual.

US survey feet are units used in surveys by the U.S. Coast and Geodetic Survey and are referred to as “US feet” in this manual.

When “feet” or “inch” is selected in “Dist”, the “Feet” item will appear on the screen as below. When “meter” is selected, this item will not be displayed.

Temp.	: 
Press.	: hPa
Angle	: degree
Dist	: feet
Feet	: Int. feet

Results displayed in feet will differ according to the unit selected in this item.

28.3 Allocating Key Functions

It is possible to allocate the softkeys in Meas mode to suit the measurement conditions. It is possible to operate the SET efficiently because unique softkey allocations can be preset to suit various applications and the ways that different operators handle the instrument.

- The current softkey allocations are retained until they are revised again, even when the power is cut off.
- It is possible to register two sets of key function allocations: user setting 1 and user setting 2.
- It is possible to recall the softkey arrays registered for User 1 and User 2 as necessary.



- When softkey allocations are recorded and registered, the previously recorded key settings are cleared. When a softkey array is recalled, the key array is changed to the key array that has been recalled, clearing the previous key array. Be sure to remember this.

• The following are the softkey allocations when the SET was shipped.

Page 1 [DIST] [ SHV] [0SET] [COORD]

Page 2 [MENU] [TILT] [H.ANG] [EDM]

Page 3 [MLM] [OFFSET] [REC] [S-O]

● **The following functions can be allocated to the softkeys.**

[DIST]	: Distance measurement
[▲ SHV]	: Switch between angle display and distance display
[0SET]	: Set horizontal angle to 0
[COORD]	: Coordinates measurement
[REP]	: Repetition measurement
[MLM]	: Missing line measurement
[S-O]	: Setting-out measurement
[OFFSET]	: Offset measurement
[REC]	: To Record menu
[EDM]	: Setting EDM
[H.ANG]	: Set required horizontal angle
[TILT]	: Display tilt angle
[MENU]	: To Menu mode (Coordinates measurement, setting-out measurement, offset measurement, repetition measurement, missing line measurement, REM measurement, resection measurement, surface area measurement, set-out line, set-out arc, point projection, intersections, traverse)
[REM]	: REM measurement
[RESEC]	: Resection measurement
[R/L]	: Select horizontal angle right/left
[ZA / %]	: Switch between zenith angle/slope in %
[HOLD]	: Hold horizontal angle/release horizontal angle
[RCL]	: Display final measurement data
[D_OUT]	: Output measurement results to an external instrument
[AIM]	: Return signal
[AREA]	: Surface area measurement
[F/M]	: Switch between meters/feet
[HT]	: Set the instrument station height and target height
[S-O LINE]	: Setting-out line measurement
[S-O ARC]	: Setting-out arc measurement
[P-PROJ]	: Point projection measurement
[INTSCT]	: Intersections measurement
[TRAVER]	: Traverse adjustment
[--]	: No functions set

● **Softkey Allocation Examples**

It is possible to allocate the same key to each page (example 1). The same function can be allocated to more than one key on the same page (example 2). And it is also possible to allocate a function to only one key (example 3).

Allocation example 1:

P1 [DIST] [▲ SHV] [H.ANG] [EDM]

P2 [DIST] [▲ SHV] [H.ANG] [EDM]

28. CHANGING THE SETTINGS

Allocation example 2:

P1 [DIST] [DIST] [▲ SHV] [▲ SHV]

Allocation example 3:

P1 [DIST] [▲ SHV] [---] [---]

►PROCEDURE Allocating functions

1. Select "Key function" in Config Mode.
Select "Define." Currently allocated softkeys are displayed in <Key function>.
2. Align the cursor with the softkeys whose allocation you want to change using {▶}/{◀}.
The cursor of the selected softkey flashes.
3. Change the softkey function using {▲}/{▼}.
Set the softkey function and its location by pressing {▶}/{◀}. The set softkey stops flashing and the cursor flashes on the next softkey.
4. Repeat steps 2 to 3 only as many times as necessary.
5. Press [OK] to record the allocations and restore <Key function>.
The functions with their new allocations are displayed in Meas mode.

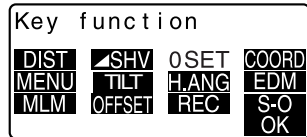

►PROCEDURE Registering an allocation

1. Allocate functions to the softkeys.
[F] "PROCEDURE Allocating functions"

2. Select "Key function" in Config mode.
3. Select "Registration."
Select either "User 1" or "User 2" as the softkey array to be registered.
4. Press {←}. The softkey array is registered as user 1 or user 2 and <Key function> is restored.

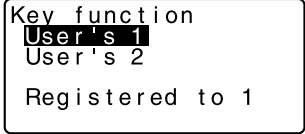

```
Key function
User's 1
User's 2
Registered to 1
```

► **PROCEDURE** Recalling an allocation

1. Select "Key function" in Config Mode.
2. Select "Recall." Select the key array for either User 1, User 2, or Default (setting when the SET was shipped), and press {←}. <Key function> is restored. This displays the functions in the recalled array in Meas mode.

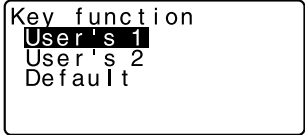

```
Key function
User's 1
User's 2
Default
```

28.4 Changing Password

Set password can be changed.

- No password was set when the SET was shipped.

► **PROCEDURE** Changing password

1. Select "Change Password" in Config mode.

28. CHANGING THE SETTINGS

- Input old password and press {←}.
{←}.

```
Change password
Old password
:*****
```

- Input new password twice and press {←}. The password is changed and <Config> is restored.

```
Change password
New password
:*****
New password again
:*****
```

- If no password was input as new password and {←} is pressed, no password is set.



- Input range of password: 3 or more characters and 8 or fewer characters

28.5 Restoring Default Settings

The following explains the two methods of restoring default settings:

Restoring set items to initial settings and turning power on. Initializing the data and turning power on.

- Restore the following items to the initial settings when the SET was shipped.
EDM setting, Config mode settings (including softkey arrays)
 About initial settings when the SET was shipped: "28.1 EDM Settings", "28.3 Allocating Key Functions"
- Initialize the data. The following data is initialized.
Data within all jobs
Known point data within memory
Code data within memory
Dial-up menu password

►PROCEDURE Restoring set items to initial settings and turning power on

- Turn the power off.
- While pressing {F4} and {BS}, press {ON}.

3. The SET is turned on, "Default set" appears on the screen and all items are restored to their initial settings.

► **PROCEDURE** Initializing the data and turning the power on

1. Turn the power off.
2. While pressing {F1}, {F3} and {BS}, press {ON}.
3. The SET is turned on, "Clearing memory..." appears on the screen and all items are restored to their initial settings.

29. WIRELESS COMMUNICATION USING *BLUETOOTH* TECHNOLOGY

Bluetooth wireless technology allows the SET to communicate wirelessly with other *Bluetooth* devices.



- Wireless communication using *Bluetooth* technology is an optional function. For availability of this option in your country, and for further information regarding this technology, contact your local dealer.
- Use of this technology must be authorized according to telecommunications regulations of the country where the instrument is being used. Contact your local dealer in advance.
- A radio station license is not required.
- Sokkia Topcon Co., Ltd. is not liable for the content of any transmission nor any content related thereto. When communicating important data, run tests beforehand to ascertain that communication is operating normally.
- Do not divulge the content of any transmission to any third party.
- Before starting transmission, check that operation will not take place within the vicinity of portable premises radio equipment or specified low-power radio equipment.
- In the case that the instrument causes radio interference with portable premises radio equipment, terminate the connection immediately and take measures to prevent further interference (e.g. connect using an interface cable). In the case that the instrument causes radio interference with portable specified low-power radio equipment, contact your local dealer.
- When using other compatible *Bluetooth* devices, perform communication within a line-of-sight distance of approximately 2m. This distance becomes shorter when obstacles block the line of sight. Wood, glass and plastic will not impede communication. However, wood, glass and plastic containing metal frames, plates, foil and other heat shielding elements as well as coatings containing metallic powders may adversely affect *Bluetooth* communication and concrete, reinforced concrete, and metal will render it impossible. Use a vinyl or plastic cover to protect the instrument from rain and moisture.
- Perform communication at a distance of 3m or more from microwave ovens, which can cause significant interference. The SET should also not be used within proximity to televisions and radios. Even though there may be no adverse effects with regard to *Bluetooth* communication, moving a *Bluetooth* compatible SET closer to said equipment may result in electronic noise in sound or images, adversely affecting the signal reception of televisions and radios.
- Change location when proximity to a wireless device or broadcast station results in communication failure.
- When using the SET near IEEE802.11b or IEEE802.11g standard wireless LAN devices or other devices that operate on the 2.4GHz ISM band, interference

may result, causing transmission speed to slow or even disrupting the connection completely. Turn off all devices not being used.

- The radio waves used by the SET may be absorbed or scattered by rain, fog, and moisture from the human body with the limit of usable range becoming lower as a result. Similarly, usable range may also shorten when performing communication in wooded areas. Moreover, as wireless devices lose signal strength when close to the ground, perform communication at as high a position as possible.
- Sokkia Topcon Co., Ltd. cannot guarantee that the SET will operate properly with all *Bluetooth* devices on the market.



Frequency bands

Bluetooth communication with the SET uses the 2.4 GHz frequency band. This is the same band used by industrial, scientific, and medical (ISM) equipment such as microwaves, portable premises radio equipment (license required) and portable specified low-power radio equipment (license-exempt) used in factory production lines, and IEEE802.11b/IEEE802.11g standard wireless LAN devices.

Using the SET within proximity to the above devices may result in interference causing communication failure or reduction of transmission speed.

Televisions and radios use a different frequency band.

Even if the SET is used within proximity to the above equipment with no adverse effects with regard to transmission, moving a *Bluetooth* compatible device (including the SET) closer to said equipment may result in electronic noise in sound or images.

29.1

Necessary settings for *Bluetooth* communication

Bluetooth wireless communication settings are performed in "Comms setup" in Config Mode.

►PROCEDURE Basic Settings

1. Select "Comms setup" in Config mode

29. WIRELESS COMMUNICATION USING BLUETOOTH TECHNOLOGY

2. Set "Wireless" to "Yes".

```
Wireless      : Yes
Bluetooth setup
Link device list
My device info
```

3. Select "Bluetooth setup".

```
Wireless      : Yes
Bluetooth setup
Link device list
My device info
```

4. Set "Mode" to either "Master" or "Slave".

  Bluetooth connections

```
Mode          : Slave
Authentication : No
Passkey
:****
Check sum     : No
```

5. Set "Link".

Select a companion device from among the *Bluetooth* devices registered in the SET using {◀/▶}.

 Registering devices:
"PROCEDURE Registering
Bluetooth companion devices"

```
Mode          : Master
Link          : DEVICE1
Authentication : No
Passkey
:****
Check sum     : No
```

- "Link" setting is not necessary when "Mode" is set to "Slave".

6. Set "Authentication". Select "Yes" or "No".

7. Set "Passkey". Set the same passkey as that for your *Bluetooth* device.

- Up to 16 numeral characters can be input. "0123" is the factory setting. Input characters will be displayed as asterisks (e.g. "*****").

8. Set check sum setting.



- Even when "Authentication" is set to "No", a passkey is requested when authentication is set on the *Bluetooth* device being used.
- When "Wireless" is set to "Yes", communication settings will not be displayed. It is recommended that the check sum setting is set to correspond with those of the *Bluetooth* device.



Bluetooth connections

- Communication between a pair of *Bluetooth* devices requires one device to be set as the "Master" and the other as the "Slave". To initiate connections from the SET side, set the SET as the "Master" device. To initiate connections from the paired device side, set the SET as the "Slave" device.

► PROCEDURE Registering *Bluetooth* companion devices

1. Select "Comms setup" in Config mode.
2. Set "Wireless" to "Yes".
3. Select "Link device list".
4. Register your *Bluetooth* device(s). Select a device and press **[EDIT]** to update related information.
 - Select a device and press **{←}** to show details. Press **[PREV]/[NEXT]** to display details of the previous/next device.

```
Wireless      : Yes
Bluetooth setup
Link device list
My device info
```

```
Link device list
DEVICE1
DEVICE2
DEVICE3
DEVICE4
EDIT  DEL
```

```
Device (Details)
Name:
  DEVICE2
BD_ADDR:
  0123456789AB
PREV  NEXT
```

29. WIRELESS COMMUNICATION USING BLUETOOTH TECHNOLOGY

- Press **[DEL]** to delete information for the selected device.

```
DEVICE1
deletion
Confirm?
NO YES
```

5. Input "Name" (device name) and "BD ADDR" (address) and press **[REG]**.

- 12 hexadecimal digits can be input.
- By pressing **[INQ]**, it is also possible to inquire about devices in the immediate vicinity and register their address. Select an address from the list of devices discovered and press **[OK]**. The address is displayed "BD ADDR". (If SET cannot find any devices within 30 sec., the inquiry will be canceled.)

```
Device registration
Name:
DEVICE1
BD_ADDR:
0123456789AB
INQ REG
```

```
Inquiry...
0123456789AB
123456789ABC
23456789ABCD
3456789ABCDE
STOP OK
```

►PROCEDURE Displaying *Bluetooth* information for the SET

1. Select "Comms setup" in Config mode.
2. Set "Wireless" to "Yes" .
3. Select "My device info". The *Bluetooth* information for the SET is displayed. The "BD ADDR" for the SET must be registered on your *Bluetooth* device.

```
Wireless : Yes
Bluetooth setup
Link device list
My device info
```

```
Bluetooth ID:B02706
Firmware:VerX.X.X
BD_ADDR:
ABCDEF012345
```





Bluetooth Device Address

This is a number unique to one particular *Bluetooth* device used to identify devices during communication. This number consists of 12 characters

(numbers 0 to 9 and letters from A to F). Some devices may be referred to by their *Bluetooth* device address.

29.2 Establishing a connection between the SET and paired *Bluetooth* device

When "Wireless" is set to "Yes" in "Comms setup" in Config mode [] / [] is displayed in Meas mode.

► PROCEDURE

1. Complete the necessary settings for *Bluetooth* communication.

 "29.1 Necessary settings for *Bluetooth* communication"



2. Press [] in the fourth page of Meas mode screen. The *Bluetooth* module in the SET powers on and connection starts.

The *Bluetooth* icon indicates communication status.

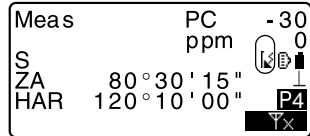
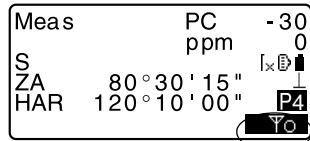
 "5.2 Display Functions"



Note

- When "Mode" in "*Bluetooth* setup" is set to "Slave", the establishing of a connection can only be initiated from the "Master" *Bluetooth* device.
- When "Mode" in "*Bluetooth* setup" is set to "Master", SET will attempt to establish a connection with the designated *Bluetooth* device (specified in "Link" in "*Bluetooth* setup").
- Softkeys (in Meas mode and <Aiming>)
 - []: Press to enter waiting status ("Mode" is set to "Slave")/establish a connection ("Mode" is set to "Master")
 - []: Press to cancel the connection/exit waiting status ("Mode" is set to "Slave")/stop establishing or cancel a connection ("Mode" is set to "Master")

29. WIRELESS COMMUNICATION USING BLUETOOTH TECHNOLOGY

- Audio tones

(While connecting/disconnecting)

Start paging/waiting:	short beep
Connection successfully established:	long beep
Connection canceled/being canceled:	two short beeps
Paging failed/waiting time out:	two short beeps

(While inquiring about other *Bluetooth* devices)



New device discovered:	short beep
Inquiry complete:	long beep

29.3

Measurement using *Bluetooth* communication

Data collectors can also be set as companion devices for wireless communication and can be used to initiate measurement.

► PROCEDURE Performing measurement using a data collector

1. Complete the necessary settings for *Bluetooth* communication.
 "29.1 Necessary settings for Bluetooth communication"
2. Verify the current connection status by checking the *Bluetooth* icon in the Meas mode screen.
 "29.2 Establishing a connection between the SET and paired Bluetooth device"
3. Initiate measurement using your *Bluetooth* device (e.g. a data collector). SET will respond and measurement will start. Measured values are then displayed in the Meas mode screen.

29.4 Registering/Outputting data using *Bluetooth* communication

It is possible to set a computer as the companion device and register known point data or output JOB data via wireless communication.

► **PROCEDURE** Entering known point coordinate data from an external instrument

1. Complete the necessary settings for *Bluetooth* communication.
☞ "29.1 Necessary settings for Bluetooth communication"
2. Verify the current connection status by checking the *Bluetooth* icon in the Meas mode screen.
☞ "29.2 Establishing a connection between the SET and paired Bluetooth device"
3. Register known point data in Memory mode.
☞ "25.1 Registering/Deleting Known Point Data
PROCEDURE Entering known point coordinate data from an external instrument"
Coordinate data starts being entered from the external instrument.
 - If a connection has not yet been established, the screen at right is displayed. (Screens differ depending on the "Mode" setting. The displayed screen appears when "Mode" is set to "Slave".)
After a connection has been established, the data is entered.

Comms input
Waiting for
connection...

► **PROCEDURE Outputting JOB data to a host computer**

1. Complete the necessary settings for *Bluetooth* communication.
☞ "29.1 Necessary settings for Bluetooth communication"
2. Verify the current connection status by checking the *Bluetooth* icon in the Meas mode screen.
☞ "29.2 Establishing a connection between the SET and paired Bluetooth device"
3. Output JOB data in Memory mode.
☞ "26. OUTPUTTING JOB DATA PROCEDURE Outputting JOB data to host computer"
SET starts outputting data.

- If a connection has not yet been established, the screen at right is displayed. (Screens differ depending on the "Mode" setting. The displayed screen appears when "Mode" is set to "Slave".)
After a connection has been established, the data is output.

Comms output	
Format	SDR33
Sending	12

Comms output Waiting for connection...
--

30. WARNING AND ERROR MESSAGES

The following is a list of the error messages displayed by the SET and the meaning of each message. If the same error message is repeated or if any message not shown below appears, the instrument has malfunctioned. Contact your local dealer.

Attached file err

The file extension of the selected file is not ".sdr".

BadCondition

The air is shimmering a lot, etc., measuring conditions are poor.

The center of the target cannot be sighted.

Resight the target.

Unsuitable distance measurement conditions when reflectorless measurement is set. When reflectorless measurement is set, distance cannot be measured because the laser beam is striking at least two surfaces at the same time.

Choose a single surface target for distance measurement.

Calculation error

Coordinates identical to the known point coordinates observed during resection exist. Set another known point so that the known point coordinates do not coincide.

Can't move dir

An error occurred while trying to move a directory on the FTP server.

Checksum error

A sending/repetition error has occurred between the SET and external equipment.

Send/receive the data again.

Clock error

Clock error occurs when the voltage of the lithium battery decreases or the battery itself is depleted. For details on replacing lithium batteries contact your local dealer.

Communication error

Comm err

A reception error has occurred in coordinate data from an external instrument.

Check the settings of parameters concerning communication conditions.

 "28.2 Configuration -Config Mode-"

30. WARNING AND ERROR MESSAGES

Delete mail err

An error occurred while trying to delete received e-mail.

Encode err

Correct encoding (HEXBIN) is not used. Check that HEXBIN is set in the encoding settings for the e-mail software being used.

FileName Full

This file name cannot be used again. File names made up of said file name plus all possible single-letter suffixes "a" to "z" already exist on the server.

File not exist

This file does not exist in the current directory.

Flash write error!

Flash mount error!

FlashMem err

It is impossible to read in data.
Contact your local dealer.

FTPfile open err

An error occurred while trying to open a file on the FTP server.

FTP receive err

An error occurred while reading in a file from the FTP server.

FTP send err

An error occurred while writing a file to the FTP server.

FTPSvr con error

An error occurred while connecting to the FTP server. Check the FTP server settings.

FTPSvr search err

An error occurred while obtaining a file list from the FTP server.

Incorrect Password

Input password does not match set password. Input correct password.

Invalid baseline

During setting-out line measurement or point projection measurement, baseline has not been defined correctly.

Mail not exist

There is no e-mail for the SET. Check that the e-mail sent included a correct subject line.

Mail search err

The mail list could not be obtained due to an error during reception. Try again.

Memory is full

There is no more room to enter data.

Record the data again after deleting unnecessary data from the JOB or coordinate data from the memory.

Need 1st obs

During missing line measurement, the observation of the starting position was not completed normally.

Sight the starting position accurately and press **[OBS]** to perform the measurement again.

Need 2nd obs

During missing line measurement, the observation of the target was not completed normally.

Sight the target accurately and press **[MLM]** to perform the measurement again.

Need offset pt.

Observation of the offset point during offset measurement was not completed normally.

Sight the offset point accurately and press **[OBS]** to perform the measurement again.

Need prism obs

During REM measurement, the observation of the target was not completed normally.

Sight the target accurately and press **[OBS]** to perform measurement again.

New password Diff.

Passwords input when setting a new password do not match.

Input the same password twice.

No attached file

There is no file attached to the selected e-mail.

30. WARNING AND ERROR MESSAGES

No data

When searching for or reading in coordinate data or searching for code data, the search stopped either because the item in question does not exist or the data volume is large.

No solution

The calculation of the instrument station coordinates during resection does not converge.

Assess the results and if necessary, perform the observation again.

Intersect point could not be calculated. Either necessary data items were not input or the Intersect point does not exist.

North/East is null, Read error

The Northing or Easting field of the given coordinate is null.

Input the coordinate.

Out of range

The tilt of the instrument exceeds the tilt angle compensation range during measurement.

Level the instrument again.

 "7.2 Levelling"

Out of value

During gradient % display, the display range (less than $\pm 1000\%$) has been exceeded.

During REM measurement, either the vertical angle has exceeded horizontal $\pm 89^\circ$ or the measured distance is greater than 9999.999m.

Install the instrument station far from the target.

The instrument station coordinates calculated during resection are too high. Perform the observation again.

During setting-out line measurement, scale factor has been less than 0.100000 or exceeded 9.999999.

During area calculation, results exceeded the display range.

POPsvr con error

Connection to the POP server failed. Check the POP server settings.

PPP err

An error occurred during dial-up connection. Check that the phone and cable are connected correctly and that the correct login name and password have been entered.

Print or send first

JOB data output (transmission to the host computer or output to the printer) is not completed before JOB is cleared.

Either transmit the JOB to be cleared to the host computer or output it to the printer.

Pt already on route

Traverse tried to close on a traverse point other than the Start pt. during automatic route search. Press any key to return to the last point found in automatic route search. Either select the next traverse point to continue the current search or specify the Start pt. to close a closed-loop traverse.

RAM cleared

(Displayed when the SET is switched on) The resume function does not work because more than one week (memory back-up period) has passed since the SET was last switched off.

After more than one week, even though "Resume" is still set to "On," the resume function has been canceled.

Rcv mail err

An error occurred while e-mail was being received.

Same coordinates

The same values are input in Pt.1 and Pt.2 in setting-out line measurement. SET cannot define the baseline.

SDR format err

The file read in is not SDR format. Check the file.

Send mail err

An error occurred while e-mail was being sent.

Signal off

Measuring conditions are poor, and there is not any reflective light for measuring distances.

Resight the target. When using reflective prisms, effectiveness will be improved by increasing the number of prisms used.

Station coord is Null

Cannot calculate. Station point coordinate is set to "Null".
Input the coordinate.

30. WARNING AND ERROR MESSAGES

Temp Range OUT

SET is outside useable temperature range and accurate measurement cannot be performed. Repeat measurement within the appropriate temperature range. If the SET is used under direct sunlight, use an umbrella to protect it against the heat of the sun.

Time out (during measurement)

Measuring conditions are poor, and due to the insufficient amount of reflective light, measuring could not be carried out within the time specified. Resight the target. When using reflective prisms, effectiveness will be improved by increasing the number of prisms used.

Time out (during SFX dial-up communication)

Operation was not completed within the time specified so was forcibly terminated.

Too short

Input password has fewer than 3 characters. Password must have 3 or more characters and 8 or fewer characters.

The calculated result is too large to be displayed on the screen in its totality.

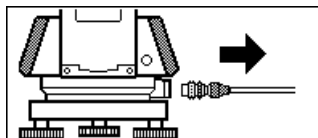

If the printer cable is attached during measurement, measurement cannot be carried out correctly. SET notifies you by displaying the screen above and beeping. When the cable is removed, the previous screen is restored. If connected SDR or host computer is turned Off, the above screen appears. This is normal, and does not indicate trouble. If connected SDR or host computer is turned On again or cable is connected again, the previous screen is restored.

31. CHECKS AND ADJUSTMENTS

A SET is a precision instrument that requires fine adjustments. It must be inspected and adjusted before use so that it always performs accurate measurements.

- Always perform checking and adjustment in the proper sequence beginning from "31.1 Plate Level" to "31.8 Guide Light".
- In addition, the instrument should be inspected with special care after it has been stored a long time, transported, or when it may have been damaged by a strong shock.
- Make sure the instrument is securely set up and stable before performing checks and adjustments.

31.1 Plate Level

The bubble tube is made of glass, so it is sensitive to temperature changes or to shock. Check and adjust it as outlined below.

► PROCEDURE Checking and adjusting

1. Level the instrument and check the position of the bubble of the plate level.
☞ "7.2 Levelling" steps 3 to 5
2. Turn the upper part through 180° and check the bubble position. If the bubble is still centered, no adjustment is necessary. If the bubble is off-center, adjust as follows.
3. Correct half of the bubble displacement using levelling foot screw C.

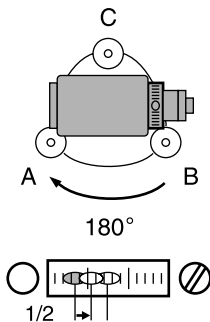

31. CHECKS AND ADJUSTMENTS

- Correct the remaining half of the displacement by using the adjustment pin to rotate the plate level adjustment screw. When the plate level adjustment screw is turned in the counterclockwise direction, the bubble moves in the same direction.
- Rotate the top of the instrument and continue adjustments until the bubble remains centered for any position of the upper part. If the bubble does not move to the center even when the adjustment has been repeated, ask your local dealer to adjust it.

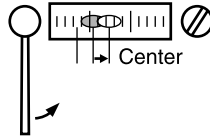

31.2 Circular Level

► PROCEDURE Checking and adjusting

- Perform the plate level inspection and adjustment or carefully use the plate level to level the instrument.
☞ "7.2 Levelling" steps 1 to 2
- Check the position of the bubble of the circular level.
If the bubble is not off-center, no adjustment is necessary.
If the bubble is off-center, perform the following adjustment.

3. First confirm the off-center direction.
Use the adjusting pin to loosen the circular level adjustment screw on the side opposite to the direction the bubble is displaced to move the bubble to the center.

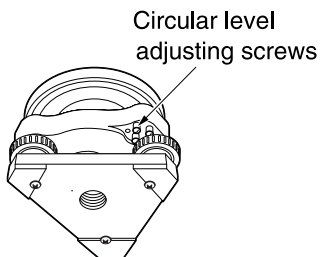

4. Adjust the adjusting screws until the tightening tension of the three screws is the same to align the bubble in the middle of the circle.



- Be careful that the tightening tension is identical for all the adjusting screws.
- Also, do not over-tighten the adjusting screws as this may damage the circular level.

31.3 Tilt Sensor

If the tilt angle shown on the display shifts from tilt angle 0° (zero point), the instrument is not correctly levelled. This will adversely affect angle measurement. Perform the following procedure to cancel the tilt zero point error.

► PROCEDURE Check

1. Carefully level the instrument. If necessary, repeat the procedures to check and adjust the bubble levels.
2. Set the horizontal angle to 0° .
Press **[OSET]** twice in the first page of the Meas mode screen to set the horizontal angle to 0° .

31. CHECKS AND ADJUSTMENTS

3. Select "Instr. const" in the Config. mode screen to display the current correction constant in the X (sighting) direction and Y (horizontal axis) direction.

```
Config
Obs.condition
Instr.config
Instr.const
Comms setup
Unit
```

```
Instr. const
Tilt X400 Y400
Collimation
```

Select "Tilt X Y" and press **{←}** to display the tilt angle in the X (sighting) direction and Y (horizontal axis) direction.

```
Tilt offset
X -0°01'23"
Y 0°00'04"
HAR 00°00'00"
Take F1
OK
```

4. Wait a few seconds for the display to stabilize, then read the automatically compensated angles X1 and Y1.
5. Loosen the horizontal clamp and turn the instrument 180° while referring to the displayed horizontal angle, then retighten the clamp.

6. Wait a few seconds for the display to stabilize, then read the automatically compensated angles X2 and Y2.

```
Tilt offset
X -0°00'03"
Y 0°00'04"
HAR 180°00'00"
Take F2
OK
```

7. In this state, calculate the following offset values (tilt zero point error).

$$Xoffset = (X1+X2)/2$$

$$Yoffset = (Y1+Y2)/2$$

If one of the offset values (Xoffset, Yoffset) exceeds $\pm 20''$, adjust the value using the following procedure.

When the offset value falls within the range $\pm 20''$, adjustment is not necessary.

Press **{ESC}** to return to <Instr. const>.

►PROCEDURE Adjustment

8. Store values X2 and Y2.
Press **[OK]**. "Take F2" is displayed.
9. Rotate the top of the instrument through 180° until the displayed horizontal angle is $180^\circ \pm 1'$ and **[OK]** is displayed.
10. Wait a few seconds for the display to stabilize, then store the automatically compensated angles X1 and Y1.
Press **[YES]** to store tilt angles X1 and Y1. The new correction constant is displayed.
11. Confirm that the values are in the adjustment range.
If both correction constant are within the range 400 ± 120 , select **[YES]** to renew the correction angle. <Instr. const> is restored. Continue to step 12.
If the values exceed the adjustment range, select **[NO]** to cancel the adjustment and restore <Instr. const>. Contact your local dealer to perform the adjustment.

Tilt offset			
Current	X400	Y400	
New	X408	Y396	
		NO	YES

31. CHECKS AND ADJUSTMENTS

►PROCEDURE Recheck

12. Press {←} at <Instr. const>.
13. Wait a few seconds for the display to stabilize, then read the automatically compensated angles X3 and Y3.
14. Rotate the top of the instrument through 180°.
15. Wait a few seconds for the display to stabilize, then read the automatically compensated angles X4 and Y4.
16. In this state, the following offset values (tilt zero point error) are calculated.
 $X_{\text{offset}} = (X3+X4)/2$
 $Y_{\text{offset}} = (Y3+Y4)/2$
When both offset values fall within the range $\pm 20''$, adjustment is completed.
Press {ESC} to return to <Instr. const>.

If one of the offset values (X_{offset} , Y_{offset}) exceeds $\pm 20''$, repeat the check and adjustment procedures from the beginning. If the difference continues to exceed $\pm 20''$ after repeating the check 2 or 3 times, have your local dealer perform the adjustment.

31.4 Collimation

With this option you can measure collimation error in your instrument so that the SET can correct subsequent single face observations. To measure the error, make angular observations using both faces.

► Procedure

1. Display <Collimation>.

Select "Instr.const" in the Config. mode screen and select "Collimation".
2. Sight the reference point in Face 1.

Sight the reference point in Face 1 and press **[OK]**.
3. Sight the reference point in Face 2.

Rotate the instrument 180°. Sight the same point in Face 2 and press **[OK]**.
4. Set the constant.

Press **[YES]** to set the constant.

 - Press **[NO]** to discard the data and return to <Collimation>.

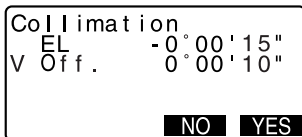

31.5 Reticle

► PROCEDURE Check 1: Perpendicularity of the reticle to the horizontal axis

1. Carefully level the instrument.
2. Align a clearly visible target (the edge of a roof for example) on point A of the reticle line.

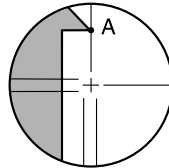

3. Use the telescope fine motion screw to align the target to point B on a vertical line.

If the target moves parallel to the vertical line, adjustment is unnecessary. If its movement deviates from the vertical line, have our service representative adjust it.

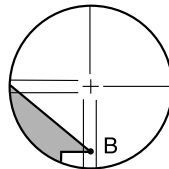

► PROCEDURE Check 2: Vertical and horizontal reticle line positions



- Perform the check procedure under slightly hazy and weakly scintillating conditions.

1. Install a target at a point about 100m in the horizontal direction from the SET.
2. Level the instrument carefully, turn on the instrument's power.



3. While the Meas mode screen is displayed and the telescope is in face left, sight the center of the target and read out the horizontal angle A1 and the vertical angle B1.

Example: Horizontal angle A1=18° 34' 00"

Vertical angle B1=90° 30' 20"

4. While the telescope is in face right, sight the center of the target and read out the horizontal angle A2 and the vertical angle B2.

Example: Horizontal angle A2=198° 34' 20"

Vertical angle B2=269° 30' 00"

5. Do the calculations:

A2-A1 and B2+B1

If A2-A1 is within 180°±20" and B2+B1 is within 360°±40", adjustment is unnecessary.

Example: A2-A1 (Horizontal angle)

=198° 34' 20" - 18° 34' 00"

=180° 00' 20"

B2+B1 (Vertical angle)

=269° 30' 00" + 90° 30' 20"

=360° 00' 20"

If the difference is large even after repeating the check 2 or 3 times, have our service representative perform the adjustment.

31.6 Optical Plummet

►PROCEDURE Check

1. Carefully level the SET and exactly center a survey point in the reticle of the optical plummet.
2. Turn the upper part 180° and check the position of the survey point in the reticle.
If the surveying point is still centered, no adjustment is necessary.
If the surveying point is not still centered in the optical plummet, adjust as follows:

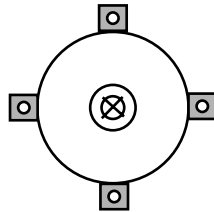

►PROCEDURE Adjustment

3. Correct half the deviation with the levelling foot screw.
4. Firmly hold down the top portion of the instrument, and remove the optical plummet knob cover, then remove the optical plummet reticle cover on the inside.
Replace the optical plummet knob cover.
Use the 4 adjusting screws of the optical plummet to adjust the remaining half of the deviation as show below.

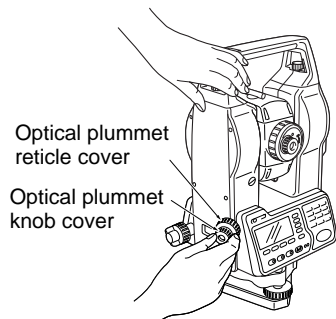
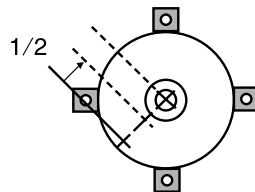

31. CHECKS AND ADJUSTMENTS

5. When the survey point is on the lower (upper) part of the illustration:

- 1 Loosen the upper (lower) screw slightly.
- 2 Tighten the lower (upper) screw by the same amount.

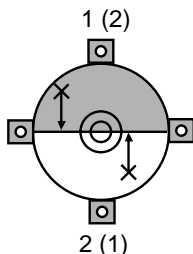

6. If the survey point is on the solid line (dotted line):

- 3 Loosen the right (left) screw slightly.
- 4 Tighten the left (right) screw by the same amount.

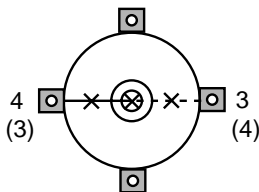

7. Check the adjustment by rotating the upper part of the instrument. The survey point should remain centered in the reticle. If necessary, repeat the adjustment.

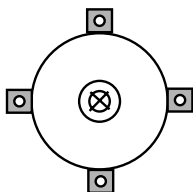

8. Remove the optical plummet knob cover, and install the optical plummet reticle cover on the inside.
Replace the optical plummet knob cover.



Do not over-tighten the 4 adjusting screws as this may cause the reticle to go out of adjustment.

31.7 Additive Distance Constant

The additive distance constant K of the SET is adjusted to 0 before delivery. Although it almost never deviates, use a baseline with a known distance precision to check that the additive distance constant K is close to 0 several times a year and whenever the values measured by the instrument begin to deviate by a consistent amount. Perform these checks as follows.



- Errors in setting up the instrument and reflective prism or in sighting the target will influence the additive distance constant. Be extremely careful to prevent such errors when performing these procedures.
- Set up so that the instrument height and the target height are identical. If a flat place is not available, use an automatic level to make sure the heights are identical.

►PROCEDURE Check

1. Find an area of flat ground where two points 100m apart can be selected.

Set up the Instrument at point A and the reflective prism at point B. Establish a point C half way between points A and B.

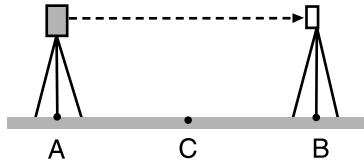

2. Precisely measure the horizontal distance between point A and point B 10 times and calculate the average value.

3. Place the SET at point C directly between points A and B and set up the reflective prism at point A.

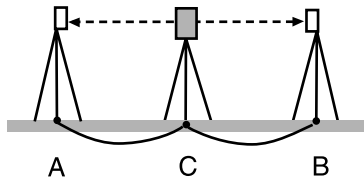

4. Precisely measure the horizontal distances CA and CB 10 times each and calculate the average value for each distance.

- Calculate the additive distance constant K as follows.
$$K = AB - (CA + CB)$$
- Repeat steps 1 to 5 two or three times.
If the additive distance constant K is within $\pm 3\text{mm}$ even once, adjustment is unnecessary. If it always exceeds this range, have our service representative perform an adjustment.

31.8 Guide Light

When the dividing line (the position where it switches back and forth from red to green) for the red and green guide lights is off centered from the reticle lines, use the following procedures to make adjustments.



- The guide light is an optional function. Set "Illum. Hold" to "Guide" in Config. mode, Use the setting page to select, check and adjust the guide light.
☞ "28.1 EDM Settings" and "35. OPTIONAL ACCESSORIES"

► PROCEDURE Checks

- Install a prism at a point about 20 meters in the horizontal direction from the SET.
- Level the instrument.
- Sight the center of the prism with the telescope (face left).
- Hold  down to turn the guide lights on.



31. CHECKS AND ADJUSTMENTS

5. Set the horizontal angle to 0° by pressing **[0SET]** twice on the first page of the Meas mode.
6. Look through the telescope to verify that the guide lights are being reflected in the prism.

If both colors (red and green) are visible: proceed to procedure 7.
If only the red or the green are visible: proceed to procedure 10.

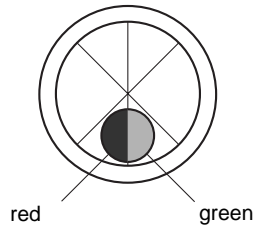

7. Move the top of the instrument slightly while looking through the telescope, measure the horizontal angle of the position that changes only to green from both colors (red and green) of the guide light colors that are reflected in the prism.
8. Move the top of the instrument slightly while looking through the telescope, measure the horizontal angle of the position that changes only to red from both colors (red and green) of the guide light colors that are reflected in the prism.
9. Calculate the difference of the angle of the horizontal angle to search for the offset direction of the dividing line of the guide lights from the measurement values of procedures 7 and 8.

Example:

(Procedure 7) The horizontal angle $0^{\circ}03'30'' = 04'30''$ to the right from the reticle line ($=0^{\circ}$ set position) of the position that changes to green only from both colors (red and green) of the colors of the guide lights that are reflected in the prism.

(Procedure 8) The horizontal angle $359^{\circ}57'00'' = 03'00''$ to the left from the reticle line ($=0^{\circ}$ set position) of the position that changes to green only from both colors (red and green) of the colors of the guide lights that are reflected in the prism.

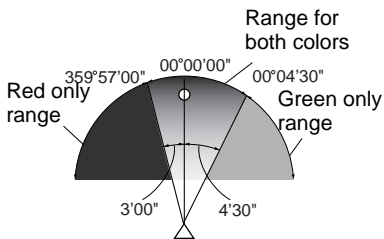

→ The angle difference for procedures 7 and 8 is $1'30''$, with this the dividing line for the green and the red shifts to the right side (the green side).

Note

The illustration depicts how the left and right colors of the guide light are reflected in a prism and seen when viewed through the telescope.

When the angle difference is more than $1'$, proceed to the adjustments for procedure 10.

When the angle difference is less than $1'$, adjustments are unnecessary.

►PROCEDURE Adjustments

- Adjust the dividing line for the red and green lights of the guide lights that are reflected in the prism so that it is centered in the reticle.
When only the red is visible, or if the dividing line shifts onto the red side: turn the guide light adjustment screw clockwise.
When only the green is visible, or if the dividing line shifts onto the green side: turn the guide light adjustment screw counterclockwise.
- Carry out a check of procedures 7 to 9 once again.
When the measurement value difference for the horizontal angle is more than $1'$, then repeat the adjustments for procedure 10.
When the measurement value difference for the horizontal angle is less than $1'$, then adjustments are complete.

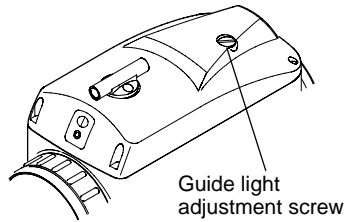

32. POWER SUPPLIES

- Operate your SET with the following combinations of power equipment.



- Be sure to carefully read the operating manuals for the battery and charger before operating them.
- Never use any combination other than those indicated below. If you do, the SET could be damaged.

Those indicated by * are standard accessories.

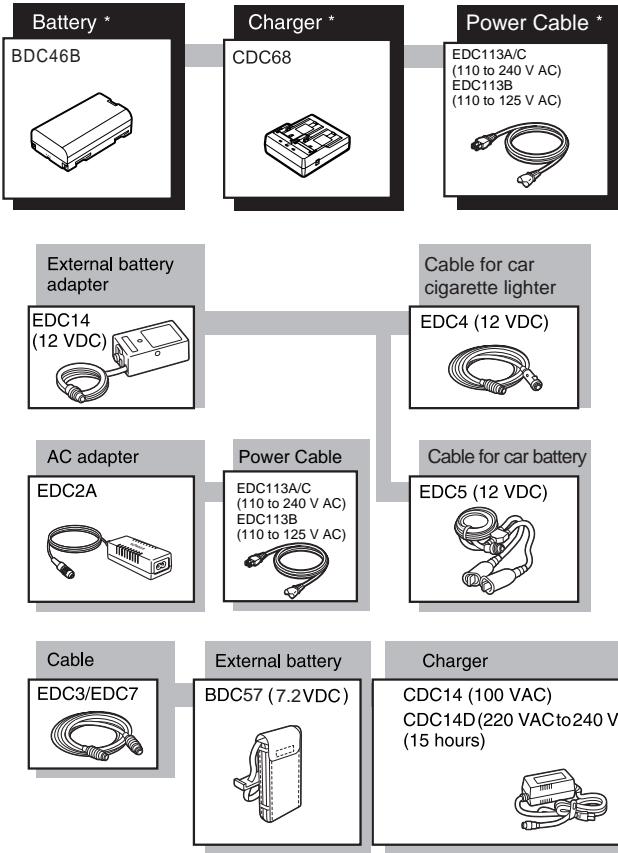

*: Standard equipment. Others are optional accessories.

● External power supply equipment

- When using EDC14, EDC2A, or BDC57, mount the BDC46B in place to maintain the balance of the instrument.
- Make sure that the car cigarette lighter is 12V DC and that its negative terminal is grounded. Use it with the car engine running.
- The EDC14 has a breaker switch. Normally the red mark appears on the breaker. If it cannot be seen, set the breaker so it is visible.

When using the car battery, the breaker will cut off if the poles are not correctly connected.

33. TARGET SYSTEM

- Because all SOKKIA reflecting prisms and accessories have standardized screws, it is possible to combine these prisms, accessories, etc. according to your objectives.
- The following are all special accessories (sold separately).
- Because these targets (*2) are coated with fluorescent paint, they reflect when there is little light.



- When using a reflecting prism equipped with a target for distance and angle measurements, be sure to direct the reflective prism correctly and sight the center of the prism target accurately.
- Each reflective prism (*1) has its own prism constant value. When changing prisms, be sure to change the prism constant correction value.
- To use the triple prism assembly AP31 or AP32 as a single prism for short distance measurements, mount the single reflective prism AP01AR in the center mounting hole of the prism holder.

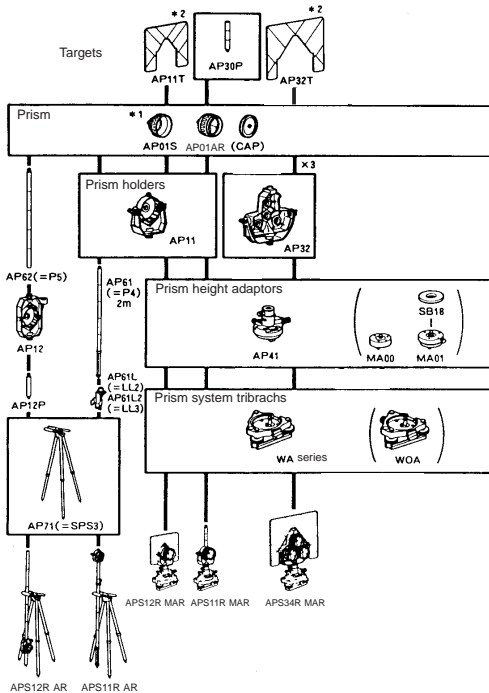

● 2-point target (2RT500-K)

This target is used for two-distance offset measurement.

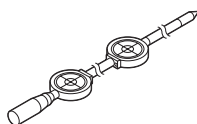

Note

- For information about reflective sheet targets and target devices, contact your local dealer.

● Instrument height adaptor (AP41)

This device is used to adjust the height of the target.

- Adjust the level of the AP41 instrument height adaptor following the checking and adjustment methods of plate level.

☞ "31.1 Plate Level"

- Adjust the optical plummet of the AP41 instrument height adaptor following the checking and adjustment methods of optical plummet.

☞ "31.6 Optical Plummet"

- When used with the SET230RK/330RK/530RK/630RK, make sure that the instrument height "236" (mm) is displayed in the instrument height adjustment window.

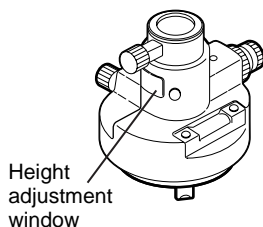

● Adjusting plate (WASeries)

Adjust the circular level of the adjusting plate for a prism following the checking and adjustment methods of circular level.

☞ "31.2 Circular Level"

34. STANDARD EQUIPMENT

Please verify that all equipment is included.

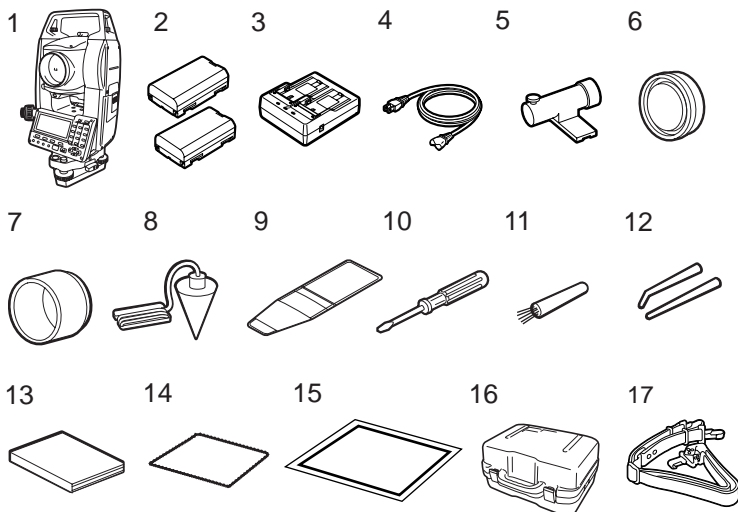

*The power cable shown here is EDC113B.

1	SET main unit	1	10	Screwdriver	1
2	Battery (BDC46B) SET230RK/230RK3/330RK/ 330RK3/530RK/530RK3	2	11	Lens brush	1
	SET630RK	1	12	Adjusting pin	2
3	Battery charger (CDC68)	1	13	Operator's manual	1
4	Power cable (EDC113A/113B/113C)	1	14	Wiping cloth	1
5	Tubular compass (CP7)	1	15	Laser caution sign-board (class3R/IIIa) (only SET230RK3/ 330RK3/530RK3)	1
6	Lens cap	1	16	Carrying case (SC196)	1
7	Lens hood	1	17	Carrying strap	1
8	Plumb bob	1			
9	Tool pouch	1			

34. STANDARD EQUIPMENT

● Tubular compass (CP7)

Slide the tubular compass into the tubular compass slot, loosen the clamp screw, then rotate the top part of the instrument until the compass needle bisects the index lines. The telescope's face left sighting direction in this position will indicate magnetic north. After use, tighten the clamp and remove the compass from the slot.

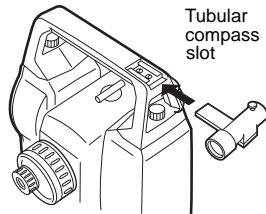

The tubular compass is susceptible to the influence of nearby magnets or metal. Such influence could cause it to fail to accurately indicate magnetic north. Do not use magnetic north as indicated by this compass for base line surveying.

● Plumb bob

The plumb bob can be used to set up and center the instrument on days when there is little wind. To use the plumb bob, unwind its cord, pass it through the cord grip piece as shown in the figure to adjust its length, then suspend it from the hook attached to the centering screw.

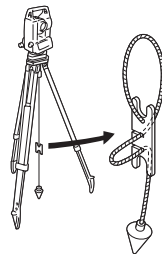

● Handle

The carrying handle can be removed from the instrument. To remove it, loosen the handle securing screw.

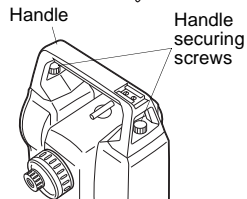

35. OPTIONAL ACCESSORIES

The following are optional accessories which are sold separately from the SET.
☞ Target and power supply optional accessories: "32. POWER SUPPLIES" and "33. TARGET SYSTEM".

● Wireless keyboard (SF14)

For SET230RK/330RK/530RK SF14 makes measuring operation and inputting data easier and speedier. The SET is operated from the Wireless Keyboard by pointing the Wireless Keyboard beam at the Beam Detector on the SET and pressing the required operation keys.

☞ Location of operation keys on the wireless keyboard:
"4.1 Parts of the Instrument",
operation: "SF14 Manual"

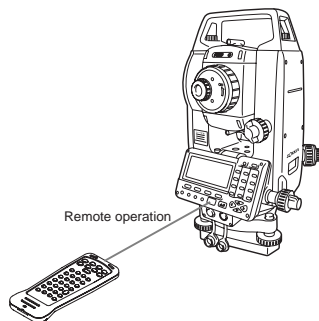

● Guide light (GDL1)

Setting-out measurements etc. can be carried out effectively using the Guide light. The Guide light is composed of a light that is divided into a red and green.

☞ Guide light status: "4.1 Parts of the Instrument", guide light ON/OFF: "5.1 Basic Key Operation"

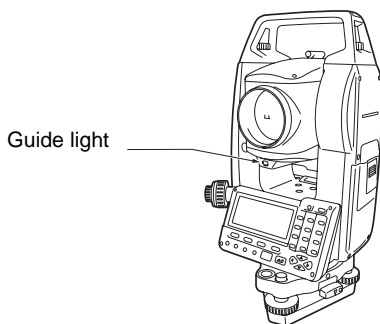

(Slight haze, visibility about 20 km, sunny periods, weak scintillation)

Light source: LED (red 626 nm/ green 524 nm) (Class 1 IEC60825-1/2001)

Distance: 1.3 to 150m

Visible range:

Right and left: about $\pm 4^\circ$, about 7m (100m)

Upward and downward:
about $\pm 4^\circ$, about 7m (100m)

Resolving power at center area (width):
less than 0.12m (100m)

● Sideplate with card slot (SCRC2A)

For SET230RK/330RK/530RK

It has a CF card slot.

 For details, see "Series 30R Operator's manual (Additional Function) Card Mode"

● Telescope eyepiece lens (EL6)

For SET630RK

Magnification: 30X

● Telescope eyepiece lens (EL7)

Magnification: 40X

Field of view: 1° 20'

● Diagonal eyepiece (DE25)

The diagonal eyepiece is convenient for observations near the nadir and in narrow spaces.

Magnification: 30X

After removing the handle from the SET, loosen the attachment screw to remove the telescope eyepiece.

Then screw the diagonal lens into place.

 Handle removal method:
"34. STANDARD EQUIPMENT"

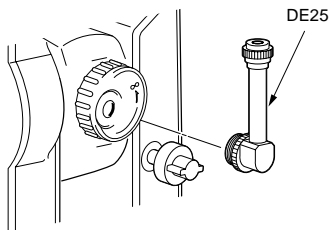

● Solar filter (OF3A)

When sighting targets where glare is present, solar observations for example, attach it to the objective lens of the SET to protect its interior and the eyes of the operator. The filter part can be flipped up without being removed.

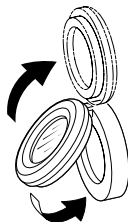

● Battery Unit (BDC55)

BDC55 is used as the power source for the ACE5 and LAP1.

● Auto-collimation eyepiece (ACE5)

The ACE5 is designed to detect a slight shift in inclination of the reflector. The BDC55 is the power source for the ACE5. The buttons on the BDC55 can also be used to operate the ACE5. For details, see the ACE5 Operator's manual.

● Laser Plummet (LAP1)

When using the LAP1, a laser is emitted from the bottom of the main unit making it easier to position the instrument over the survey point.

The BDC55 is the power source for the LAP1. The buttons on the BDC55 can also be used to operate the LAP1. For details, see the ACE5 Operator's manual.

● Printer cable (DOC46)

The SET can be connected to a Centronics specification printer which supports ESC/PTM by the printer cable DOC46. This allows direct output of data from the SET to a printer.



● Interface cable

Connect between the SET and the host computer for data output.

Computer	Cable	Notes
IBM PC/AT or compatible	DOC26	Length: 2m Pin Numbers and signal levels: RS-232C compatible
	DOC 27	D-sub connector: DOC26: 25 pins (female) DOC27: 9 pins (female)
Other computers	DOC1	No connector for attachment to a computer.

35. OPTIONAL ACCESSORIES

Connect between the SET and a cellular phone for data transfer via the Internet.

Cellular phone cable	Cable	Notes
DLR-3P (Phone: NOKIA 6310iw)	DOC121	Length: 1.5m Pin Numbers and signal levels: RS- 232C compatible D-sub connector: 9 pins (male)
SKN6315A and SYN0279B adapter (Phone: Motorola V66)	DOC122	

36. SPECIFICATIONS

Except where stated, the following specifications apply to all SETs. "SET230RK" means "SET230RK/230RK3", "SET330RK" means "SET330RK/330RK3" and "SET530RK" means "SET530RK/530RK3".

Telescope

Length:	171mm
Aperture:	45mm (EDM:48mm)
Magnification	
SET230RK/330RK/530RK:	30X
SET630RK:	26X
Image:	Erect
Resolving power:	
SET230RK/330RK/530RK:	2.5"
SET630RK:	3.5"
Field of view	1°30'
Minimum focus:	1.3m
Focussing screw:	1 speed
Reticle illumination:	5 brightness levels

Angle measurement

Horizontal and Vertical circles type:

Rotary absolute encoder

Angle units: Degree/Gon/Mil (selectable)

Minimum display: 1" (0.0002gon/0.005mil)/5" (0.0010gon/0.02mil) (selectable)

Accuracy:

 SET230RK: 2" (0.0006gon/0.010mil)

 SET330RK: 3" (0.0010gon/0.015mil)

 SET530RK: 5" (0.0015gon/0.025mil)

 SET630RK: 6" (0.0019gon/0.030mil)

(ISO 17123-3 : 2001)

Measuring time: Less than 0.5 sec

Collimation compensation: On/Off (selectable)

Measuring mode:

 Horizontal angle: Right/Left (selectable)

 Vertical angle: Zenith/Horizontal/Horizontal $\pm 90^\circ$ /% (selectable)

Tilt angle compensation

Type: Liquid 2-axis tilt sensor

Minimum display: Agrees with minimum displayed measurement angle

Range of compensation: $\pm 4'$ (± 0.0741 gon)

Automatic compensator: ON (V & H/V)/OFF (selectable)

36. SPECIFICATIONS

Distance Measurement

Measuring method:	Coaxial phase-contrast measuring system
Signal source:	Red laser diode 690nm
SET230RK/330RK/530RK/630RK:	Class 2
SET230RK3/330RK3/530RK3:	Class 3R (IEC60825-1 Amd. 2: 2001/ FDA CDRH 21CFR Part1040.10 and 1040.11 (Complies with FDA performance standards for laser products except for deviations pursuant to Laser Notice No.50, dated July 26, 2001.)) (When the prism or reflective sheet is selected in Config mode as target, the output is equivalent to Class 1).
Measuring range:	(Using SOKKIA reflective prism/reflective sheet target during normal atmospheric conditions*1/*2 is good atmospheric conditions)
SET230RK/330RK/530RK:	Reflective sheet RS90N-K*3: 1.3 to 500m (1,640ft) Reflective sheet RS50N-K*3: 1.3 to 300m (980ft) Reflective sheet RS10N-K*3: 1.3 to 100m (320ft) Compact prism CP01: 1.3 to 800m (2,620ft) Standard prism AP01AR X 1: 1.3 to 4,000m (13,120ft) 1.3 to 5,000m (16,400ft)*2 Standard prism AP01AR X 3: to 5,000 m (16,400ft) to 6,000m (19,680ft)*2 Mini pole prism OR1PA: 1.3 to 500m (1,640ft) Reflectorless (White)*4 : SET230RK/330RK/530RK: 0.3 to 200m (650ft) SET230RK3/330RK3/530RK3: 0.3 to 350m (1,140ft) Reflectorless (Gray)*5 : SET230RK/330RK/530RK: 0.3 to 80m (260ft) SET230RK3/330RK3/530RK3: 0.3 to 170m (550ft)
SET630RK:	Reflective sheet RS90N-K*3: 1.3 to 500m (1,640ft) Reflective sheet RS50N-K*3: 1.3 to 300m (980ft) Reflective sheet RS10N-K*3: 1.3 to 100m (320ft) Compact prism CP01: 1.3 to 800m (2,620ft)

Standard prism AP01AR X 1: 1.3 to 3,000m
(9,840ft)

1.3 to 4,000m (13,120ft)^{*2}

Standard prism AP01AR X 3: to 4,000m
(13,120ft)

to 5,000m (16,400ft)^{*2}

Mini pole prism OR1PA: 1.3 to 500m (1,640ft)

Reflectorless (White)^{*4} : 0.3 to 150m (490ft)

Reflectorless (Gray)^{*5} : 0.3 to 50m (160ft)

Minimum display:

Fine/Rapid measurement: 0.001m (0.01ft / 1/8inch)

Tracking measurement: 0.01m (0.1ft / 1/2inch)

Maximum slope

Prism/ reflective sheet: 9599.999m (31,496ft)

distance display:

Reflectorless: 599.999m (1,968.5ft)

Distance unit:

m/ft/US ft/inch (selectable)

Accuracy:

(Using prism)

Fine measurement: $\pm(2 + 2 \text{ ppm} \times D)$ mm

Rapid measurement (single): $\pm(5 + 2 \text{ ppm} \times D)$ mm

(Using reflective sheet target)^{*3}

Fine measurement: $\pm(3 + 2 \text{ ppm} \times D)$ mm

Rapid measurement (single): $\pm(6 + 2 \text{ ppm} \times D)$ mm

(Reflectorless (White))^{*4}

SET230RK/330RK/530RK:

Fine measurement:

$\pm(3 + 2 \text{ ppm} \times D)$ mm (0.3 to 100m)

$\pm(5 + 10 \text{ ppm} \times D)$ mm (over 100 to 200m)

Rapid measurement (single):

$\pm(6 + 2 \text{ ppm} \times D)$ mm (0.3 to 100m)

$\pm(8 + 10 \text{ ppm} \times D)$ mm (over 100 to 200m)

SET230RK3/330RK3/530RK3:

Fine measurement:

$\pm(3 + 2 \text{ ppm} \times D)$ mm (0.3 to 200m)

$\pm(5 + 10 \text{ ppm} \times D)$ mm (over 200 to 350m)

Rapid measurement (single):

$\pm(6 + 2 \text{ ppm} \times D)$ mm (0.3 to 200m)

$\pm(8 + 10 \text{ ppm} \times D)$ mm (over 200 to 350m)

SET630RK:

Fine measurement:

$\pm(3 + 2 \text{ ppm} \times D)$ mm (0.3 to 100m)

$\pm(5 + 10 \text{ ppm} \times D)$ mm (over 100 to 150m)

Rapid measurement (single):

36. SPECIFICATIONS

$\pm(6 + 2\text{ppm} \times D)$ mm (0.3 to 100m)
 $\pm(8 + 10\text{ppm} \times D)$ mm (over 100 to 150m)

(Reflectorless (Gray))*⁵

SET230RK/330RK/530RK: Fine measurement:

$\pm(3 + 2\text{ppm} \times D)$ mm (0.3 to 45m)
 $\pm(5 + 5\text{ppm} \times D)$ mm (over 45 to 80m)
Rapid measurement (single):
 $\pm(6 + 2\text{ppm} \times D)$ mm (0.3 to 45m)
 $\pm(8 + 5\text{ppm} \times D)$ mm (over 45 to 80m)

SET230RK3/330RK3/530RK3:

Fine measurement:
 $\pm(3 + 2\text{ppm} \times D)$ mm (0.3 to 100m)
 $\pm(5 + 5\text{ppm} \times D)$ mm (over 100 to 170m)
Rapid measurement (single):
 $\pm(6 + 2\text{ppm} \times D)$ mm (0.3 to 100m)
 $\pm(8 + 5\text{ppm} \times D)$ mm (over 100 to 170m)

SET630RK:

Fine measurement:
 $\pm(3 + 2\text{ppm} \times D)$ mm (0.3 to 30m)
 $\pm(5 + 5\text{ppm} \times D)$ mm (over 30 to 50m)
Rapid measurement (single):
 $\pm(6 + 2\text{ppm} \times D)$ mm (0.3 to 30m)
 $\pm(8 + 5\text{ppm} \times D)$ mm (over 30 to 50m)

Measurement mode: Fine measurement (single/repeat/average)/
Rapid measurement (single)/Tracking
(selectable)

Measuring time:

Fine measurement: 1.7 sec + every 0.9 sec.
Rapid measurement (single) 1.4 sec
Tracking measurement: 1.4 sec + every 0.3 sec.

Atmospheric correction:

Temperature input range: - 30 to 60°C (in 1°C step)/ - 22 to 140°F (in 1°F step)

Pressure input range: 500 to 1,400 hPa (in 1hPa step)
375 to 1,050 mmHg (in 1mmHg step)
14.8 to 41.3 inchHg (in 0.1inchHg step)

ppm input range: -499 to 499 ppm (in 1 ppm step)

Prism constant correction: -99 to 99 mm (in 1 mm step)

0mm fixed for reflectorless measurement

Earth curvature and refraction correction:

No/Yes K=0.142 /Yes K=0.20 (selectable)

Scale factor setting: 0.5 to 2.0

Sea level correction: No/Yes (selectable)

Bluetooth wireless technology (Optional function)

BT Qualification ID	B02706
Transmission method:	FHSS (<i>Bluetooth</i> Specification Ver.1.2 compatible)
Modulation:	GFSK (Gaussian-filtered frequency shift keying)
Frequency band:	2,400 to 2,483.5MHz
<i>Bluetooth</i> profile	SPP, DUN
Power class	Class 2
Usable range	about 2m (usable range may vary with different operating conditions)
Authentication:	Yes/No (selectable)

- *1: Slight haze, visibility about 20 km, sunny periods, weak scintillation.
- *2: No haze, visibility about 40 km, overcast, no scintillation.
- *3: Figures when the laser beam strikes within 30° of the reflective sheet target.
- *4: Figures when using Kodak Gray Card White side (reflection factor 90%) and brightness level is less than 30000 lx (a little cloudy).
- *5: Figures when using Kodak Gray Card Gray side (reflection factor 18%) and brightness level is less than 30000 lx (a little cloudy).
- *4,*5: When performing reflectorless measurement, the possible measurement range and precision will change depending on the target reflection factor, weather conditions and location conditions.

Power Supply

Power source:	Rechargeable Li-ion battery BDC46B External battery BDC57 (Option)
Battery state indicator:	4 levels
Working duration at 25 °C:	
Distance and angle measurement (Fine single measurement = every 30 sec.) :	
	BDC46B: about 7.5 hours
	BDC57(Option): about 27 hours
Angle measurement only:	
	BDC46B: about 11.5 hours
	BDC57 (Option): about 36 hours
Charging time at 25 °C:	about 2.5 hours (using CDC68) ^{*6}
BDC46B	Nominal voltage: 7.2V
	Storage temperature range: -20 to 35 °C
CDC68	Input voltage:
	with EDC113A/113C: 110 to 240 VAC 50/60Hz
	with EDC113B: 110 to 125 VAC 50/60Hz
	Charging temperature range: 0 to 40 °C

36. SPECIFICATIONS

Storage temperature range: -20 to 65 °C

- *6: Charging can take more than 2.5 hours when temperatures are either especially high or low.

General

Display:	LCD graphic display, 192 dots X 80 dots
SET230RK/330RK/530RK:	1 LCD graphic display on each face with illuminator
SET630RK:	1 LCD graphic display with illuminator
Operation panel (keyboard):	27 keys (soft function, operations, power on, light) with illuminator
Auto power-off:	5 levels (selectable)
Laser sighting function:	Provided On/Off (selectable)
Internal memory:	about 10,000 points
Data output:	Asynchronous serial, RS232C compatible Centronics compatible (with DOC46A) Printer with ESC/PTM mode (emulation function)
Sensitivity of levels:	
Plate level:	SET230RK/330RK/530RK: 30"/2 mm SET630RK: 40"/2 mm
Circular level:	10"/2 mm
Optical plummet:	
Image:	Erect
Magnification:	3X
Minimum focus:	0.3 m
Horizontal and vertical motion screw:	
SET230RK:	2 speed
SET330RK/530RK/630RK:	1 speed
Operating temperature:	-20 to 50 °C
Storage temperature range:	-30 to 70 °C
Dust and water resistance:	IP66 (IEC 60529: 2001)
Instrument height:	236 mm from tribrach bottom
Size (with handle):	165 (W) X 180 (D) X 341 (H) mm
Weight (with handle and battery):	
SET230RK:	5.6kg (12.3lb) ^{*7}
SET330RK/530RK:	5.6kg (12.2lb) ^{*7}
SET630RK:	5.4kg (11.8lb) ^{*7}

- *7: There is a slight difference in weight of horizontal and vertical fine motion screws between the SET230RK and SET530RK. This difference is reflected in the weight for pounds but not for kilograms which has been rounded off to the nearest tenth.

37. EXPLANATION

37.1 Manually Indexing the Vertical Circle by Face Left, Face Right Measurement

The 0 index of the vertical circle of your SET is almost 100% accurate, but when it is necessary to perform particularly high precision angle measurements, you can eliminate any inaccuracy of the 0 index as follows.



- If the power is cut off, the vertical circle indexing is ineffective. Do it again every time the power is turned on.

►PROCEDURE Manually indexing the vertical circle

1. Select "Obs. condition" in Config mode. Set "V manual" (vertical circle indexing method) to "Yes".

2. Go to the Meas mode screen. The vertical angle V1 is displayed under "Take F1."

```
0 Set
      Take F1
ZA HAR  V1
        0° 00' 00"
                OK
```

3. Carefully level the instrument.
4. Accurately sight a clear target with a distance of about 30m in the horizontal direction with the telescope in face left. Press **[OK]**. The vertical angle V2 is displayed under "Take F2."

```
0 Set
      Take F2
ZA HAR  V2
        0° 00' 00"
                OK
```

5. Turn the upper part through 180° and clamp it. Then set the telescope in the face right position and accurately sight the same target. Press **[OK]**. The vertical and horizontal angles are displayed. This concludes the vertical circle indexing procedure.

37.2 Atmospheric Correction for High Precision Distance Measurement

- Need for atmospheric correction

The SET measures the distance with a beam of light, but the velocity of this light varies according to the index of refraction of light in the atmosphere. This index of refraction varies according to the temperature and pressure. Near normal temperature and pressure conditions:

With constant pressure, a temperature change of 1°C: an index change of 1 ppm.

With constant temperature, a pressure change of 3.6 hPa: an index change of 1 ppm.

To perform high accuracy measurements, it is necessary to find the atmospheric correction factor from even more accurate temperature and pressure measurements and perform an atmospheric correction.

It is recommended that extremely precise instruments be used to monitor the air temperature and pressure.

- Finding the average temperature and pressure between two points in different atmospheric conditions

To precisely determine the atmospheric correction factor, the average temperature and air pressure along the measurement beam route must be taken.

Determine the temperature and pressure as follows.

Flat terrain :Use the temperature and pressure at the midpoint of the line.

Mountainous terrain :Use the temperature and pressure at the intermediate point (C).

If it is not possible to measure the temperature and pressure at the midpoint, take the temperature and pressure at the instrument station (A) and the target station (B), then calculate the average value.

Average air temperature : $(t_1 + t_2)/2$

Average air pressure : $(p_1 + p_2)/2$

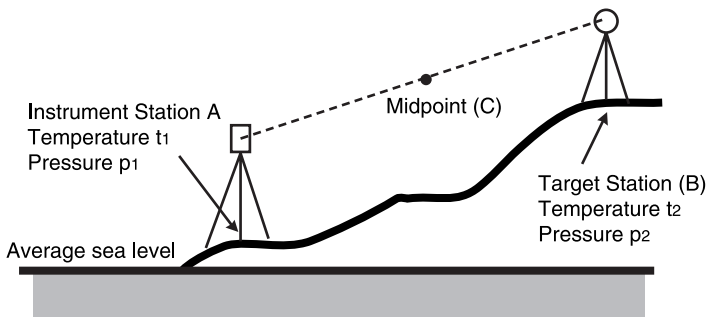

- Calculation of atmospheric correction factor allowing for humidity
The humidity has little influence, particularly on short distance measurements. The effect of humidity should be considered in cases where it is very hot and humid and high precision measurements are to be performed over a particularly long distance.

When taking humidity into consideration, calculate the atmospheric correction factor using the following formula and input the calculated ppm in instrument station data setting or EDM setting.

☞ "23.1 Recording Instrument Station Data" and "28.1 EDM Settings"

Atmospheric Correction Factor (ppm)=

$$282.59 - \frac{0.2942 \times p}{1 + 0.003661 \times t} + \frac{0.0416 \times e}{1 + 0.003661 \times t}$$

e (water vapor pressure) can be calculated using the following formula.

$$e = h \times \frac{E}{100}$$

$$E = 6.11 \times 10^{\frac{(7.5 \times t)}{(t + 237.3)}}$$

t : Air temperature (C)

p : Pressure (hPa)

e : Water vapor pressure (hPa)

h : Relative humidity (%)

E : Saturated water vapor pressure

38. REGULATIONS

Users must ensure that their instrument is compliant with the relevant regulations and legal restrictions in place in the country of use.

For users in the US

WARNING: Changes or modifications to this unit not expressly approved by the party responsible for compliance could void the user's authority to operate the equipment.

NOTE: This equipment has been tested and found to comply with the limits for a Class A digital device pursuant to Part 15 of the FCC Rules. These limits are designed to provide reasonable protection against harmful inter-ference when the equipment is operated in a commercial environment. This equipment generates, uses, and can radiate radio frequency energy and, if not installed and used in accordance with the instruction manual, may cause harmful interference to radio communications. Operation of this equipment in a residential area is likely to cause harmful interference in which case the user will be required to correct the interference at his own expense.

This transmitter must not be co-located or operated in conjunction with any other antenna or transmitter.

This equipment complies with FCC radiation exposure limits set forth for uncontrolled equipment and meets the FCC radio frequency (RF) Exposure Guidelines in Supplement C to OET65. This equipment has very low levels of RF energy that is deemed to comply without maximum permissive exposure evaluation (MPE). But it is desirable that it should be installed and operated with at least 20cm and more between the radiator and person's body (excluding extremities: hands, wrists, feet and ankles).

WARNING: Handling the cord on this product or cords associated with accessories sold with this product, will expose you to lead, a chemical known to the State of California to cause birth defects or other reproductive harm. ***Wash hands after handling.***

For users in Canada

This Class A digital apparatus meets all requirements of Canadian Interference-Causing Equipment Regulations.

Cet appareil numérique de la Class A respecte toutes les exigences du Règlement sur le matériel brouilleur du Canada.

This class A digital apparatus complies with Canadian ICES-003.

Cet appareil numérique de la classe A est conforme à la norme NMB-003 du Canada.

Operation is subject to the following two conditions: (1) this device may not cause interference, and (2) this device must accept any interference, including interference that may cause undesired operation of this device.

This equipment complies with IC radiation exposure limits set forth for uncontrolled equipment and meets RSS-210 of the IC radio frequency (RF) Exposure rules. This equipment has very low levels of RF energy that is deemed to comply without maximum permissive exposure evaluation (MPE). But it is desirable that it should be installed and operated with at least 20cm and more between the radiator and person's body (excluding extremities: hands, wrists, feet and ankles).

Series 30RK Reflectorless Total Station

Česky [Czech]

Sokkia BV potvrzuje, že výše uvedené zařízení je v souladu se základními požadavky a dalšími příslušnými ustanoveními směrnice 1999/5/ES.

Dansk [Danish]

Undertegnede, Sokkia B.V. erklærer herved, at følgende udstyr det ovennævnte udstyr overholder de væsentlige krav og øvrige relevante krav i direktiv 1999/5/EF.

Deutsch [German]

Sokkia B.V. erklärt, dass die oben genannten Instrumente in Übereinstimmung mit den grundlegenden Anforderungen und den übrigen einschlägigen Bestimmungen der Richtlinie 1999/5/EG befindet.

Eesti [Estonian]

Käesolevaga kinnitab Sokkia B.V., seadme ülal mainitud varustus direktiivi 1999/5/EÜ põhinõuetele ja nimetatud direktiivist tulenevatele teistele asjakohastele sätetele.

English

Hereby, Sokkia B.V., declares that the above-mentioned equipment is in compliance with the essential requirements and other relevant provisions of Directive 1999/5/EC.

Español [Spanish]

Por medio de la presente Sokkia B.V., declara que el equipo arriba mencionado cumple con los requisitos esenciales y cualesquiera otras disposiciones aplicables o exigibles de la Directiva 1999/5/CE.

Ελληνική [Greek]

ΜΕ ΤΗΝ ΠΑΡΟΥΣΑ Sokkia B.V., ΔΗΛΩΝΕΙ ΟΤΙ ο προαναφερόμενος εξοπλισμός ΣΥΜΜΟΡΦΩΝΕΤΑΙ ΠΡΟΣ ΤΙΣ ΟΥΣΙΩΔΕΙΣ ΑΠΑΙΤΗΣΕΙΣ ΚΑΙ ΤΙΣ ΛΟΙΠΕΣ ΣΧΕΤΙΚΕΣ ΔΙΑΤΑΞΕΙΣ ΤΗΣ ΟΔΗΓΙΑΣ 1999/5/ΕΚ.

Français [French]

Par la présente Sokkia B.V., déclare que l'équipement mentionné ci-dessus est conforme aux exigences essentielles et aux autres dispositions pertinentes de la directive 1999/5/CE.

Italiano [Italian]

Con la presente Sokkia B.V., dichiara che questo II sopra menzionato equipaggiamento è conforme ai requisiti essenziali ed alle altre disposizioni pertinenti stabilite dalla direttiva 1999/5/CE.

Latviski [Latvian]

Ar šo Sokkia B.V., deklarē, ka augstāk minētā iekārta atbilst Direktīvas 1999/5/EK būtiskajām prasībām un citiem ar to saistītajiem noteikumiem.

Lietuvių [Lithuanian]

Šiuo Sokkia B.V., deklaruoja, kad šis aukščiau mineta iranga atitinka esminius reikalavimus ir kitas 1999/5/EB Direktyvos nuostatas.

Magyar [Hungarian]

Alulírott, Sokkia B.V. nyilatkozom, hogy a a fent említett eszköz megfelel a vonatkozó alapvető követelményeknek és az 1999/5/EC irányelv egyéb előírásainak.

Malti [Maltese]

Hawnhekk, Sokkia B.V., tididikjara li t-tagħmir imsemmi hawn fuq hu konformi mal-hiġġijiet essenzjali u provvedimenti rilevanti oħrajn ta' Direttiva 1999/5/KE.

Nederlands [Dutch]

Hierbij verklaart Sokkia B.V., dat bovengenoemd toestel in overeenstemming is met de essentiële eisen en de andere relevante bepalingen van richtlijn 1999/5/EG.

Polski [Polish]

Niniejszym Sokkia B.V. oświadcza, że sprzęt wymieniony powyżej jest zgodny z zasadniczymi wymogami oraz pozostałymi stosownymi postanowieniami Dyrektywy 1999/5/EC.

Português [Portuguese]

Sokkia B.V. declara que este o equipamento acima mencionado está conforme com os requisitos essenciais e outras disposições da Directiva 1999/5/CE.

38. REGULATIONS

Slovensko [Slovenian]

Sokkia B.V. izjavlja, da je ta zgoraj omenjena oprema v skladu z bistvenimi zahtevami in ostalimi relevantnimi določili direktive 1999/5/ES.

Slovensky [Slovak]

Sokkia BV potvrdzuje, že vyššie uvedené zariadenie je v súlade so základnými požiadavkami a všetky príslušné ustanovenia Smernice 1999/5/ES.

Suomi [Finnish]

Sokkia B.V. vakuuttaa täten että ylläoleva laite tyypinen laite on direktiivin 1999/5/EY oleellisten vaatimusten ja sitä koskevien direktiivin muiden ehtojen mukainen.

Svenska [Swedish]

Härmed intygar Sokkia B.V. att den ovan nämnda utrustningen står i överensstämmelse med de väsentliga egenskapskrav och övriga relevanta bestämmelser som framgår av direktiv 1999/5/EG.

Íslenska [Icelandic]

Hér með staðfestir Sokkia B.V. að áðurnefndur búnaður er í samræmi við grundvallarskilyrði og aðrar viðeigandi kröfur í fyriræðli Evrópusambandsins 1999/5/EC.

Norsk [Norwegian]

Sokkia B.V. erklærer herved at utstyret nevnt ovenfor oppfyller de ubetingede krav og andre relevante bestemmelser i Direktiv 1999/5/EC.

For users in Mexico

Este equipo opera a título secundario, consecuentemente, debe aceptar interferencias perjudiciales incluyendo equipos de la misma clase y puede no causar interferencias a sistemas operando a título primario.

COFETEL+RCPSOZE06-471

For users in Taiwan

低功率電波輻射性電機管理辦法 (930322)

第十二條 經型式認證合格之低功率射頻電機，非經許可，公司、商號或使用者均不得擅自變更頻率、加大功率或變更原設計之特性及功能。

第十四條 低功率射頻電機之使用不得影響飛航安全及干擾合法通信；經發現有干擾現象時，應立即停用，並改善至無干擾時方得繼續使用。

前項合法通信，指依電信法規定作業之無線電通信。

低功率射頻電機須忍受合法通信或工業、科學及醫療用電波輻射性電機設備之干擾。

For users in the United Arab Emirates

Approved by TRA

SOKKIA TOPCON CO., LTD.

<http://www.sokkia.co.jp/english/>

260-63 HASE, ATSUGI, KANAGAWA, 243-0036 JAPAN

10th ed. 13-0906

©2005 SOKKIA TOPCON CO., LTD.